

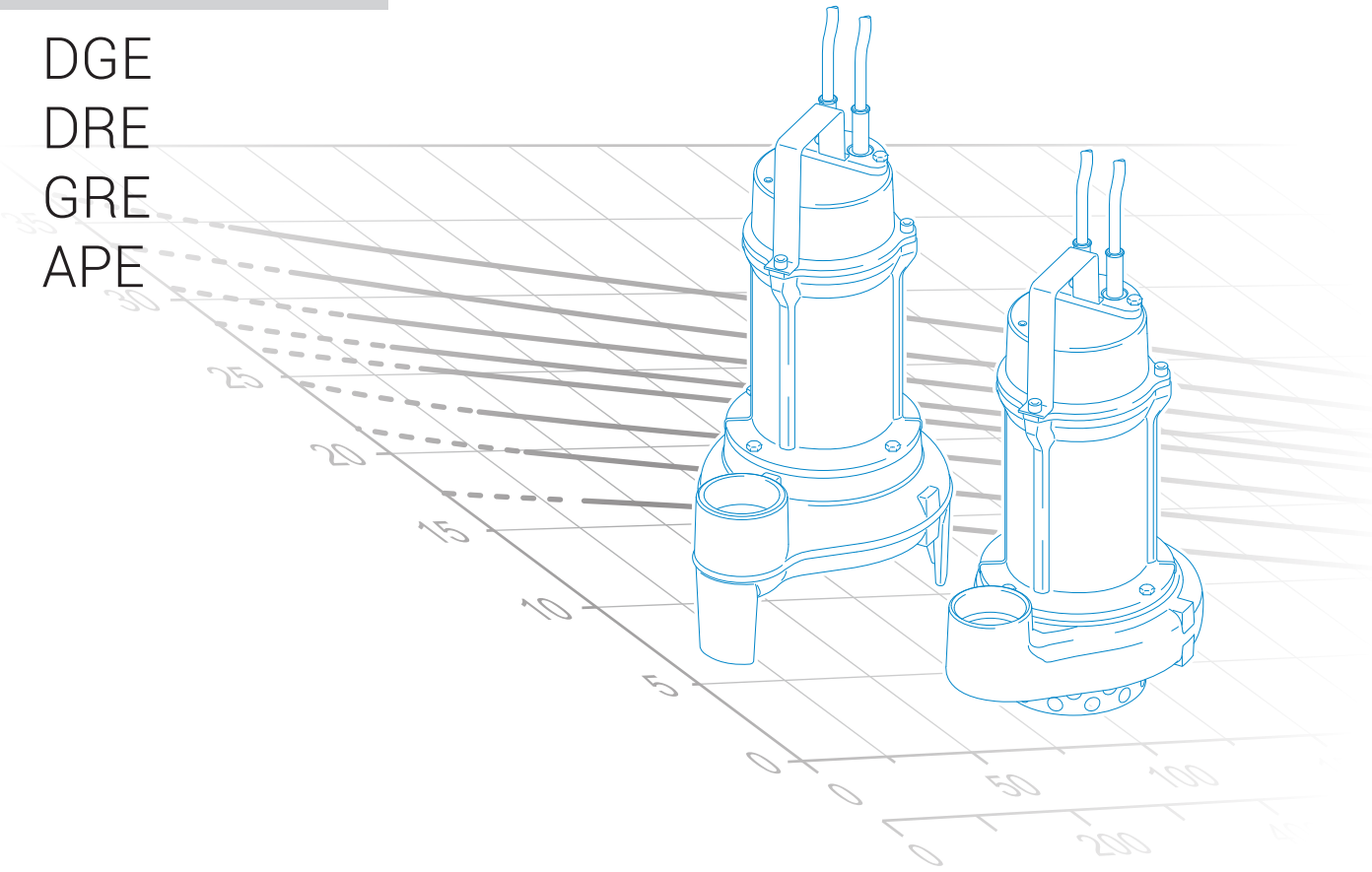

water solutions

# E SERIES

- DGE
- DRE
- GRE
- APE







water solutions

# E SERIES

DGE

DRE

GRE

APE



D A T A    B O O K L E T

## E Series

### General characteristics

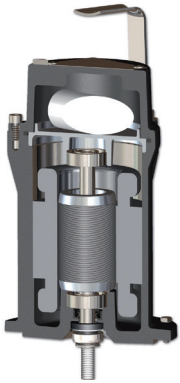

- AISI 304 stainless steel lifting and carrying handle.
- Constructed in GJL-250 cast iron
- Ecological dry motor with thermal overloads
- Single-phase models with internal capacitor. Three-phase models with motor protection relay (option).
- One mechanical seal in silicon carbide (SiC) and one lip seal

### Hydraulic families



#### DG (Draga)

page 7

Set-back vortex impeller  
Suitable with slightly soiled biological wastewaters and sewage. Suitable for domestic and residential use

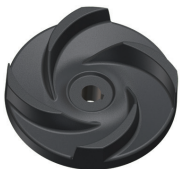

#### DR (Dreno)

page 13

Multi-channel open impeller  
Can be used with clear or slightly soiled wastewaters containing small solids, strained water, rainwater, seepage and water pumped from underground. Suitable for specifically domestic use

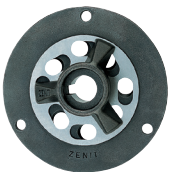

#### GR (Grinder)

page 19

Impeller with grinder system  
Suitable for lifting soiled wastewaters containing filaments or fibres, and unstrained household sewage in general

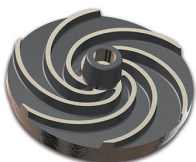

#### AP (Alta Prevalenza)

page 22

High head impeller  
Used for clear wastewater, rainwater and seepage containing small amounts of sand. The considerable manometric head makes these units suitable for irrigation and the fish processing sector

## Operating ranges

DGE

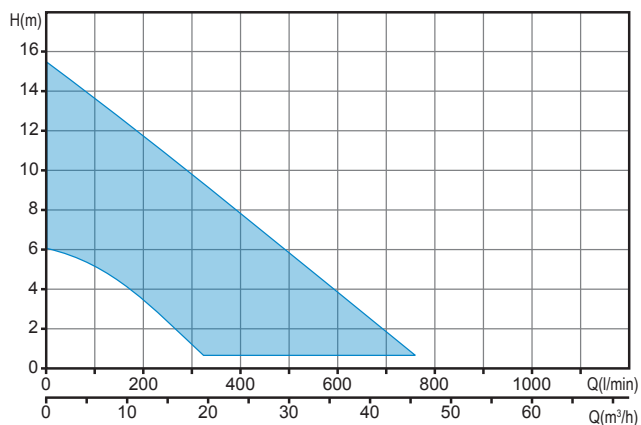

DRE

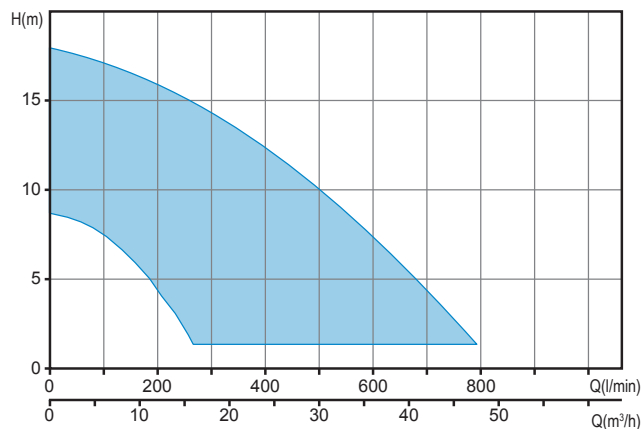

GRE

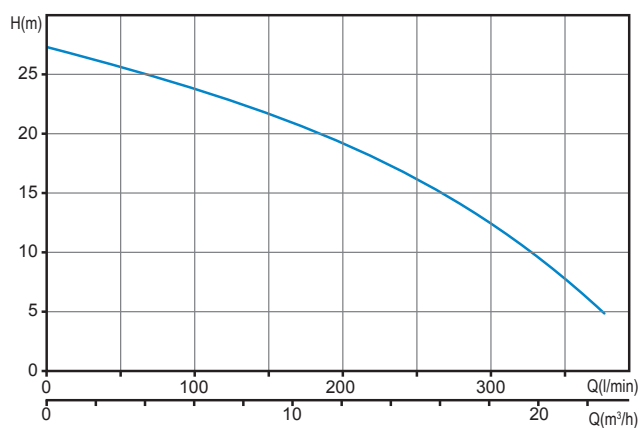

APE

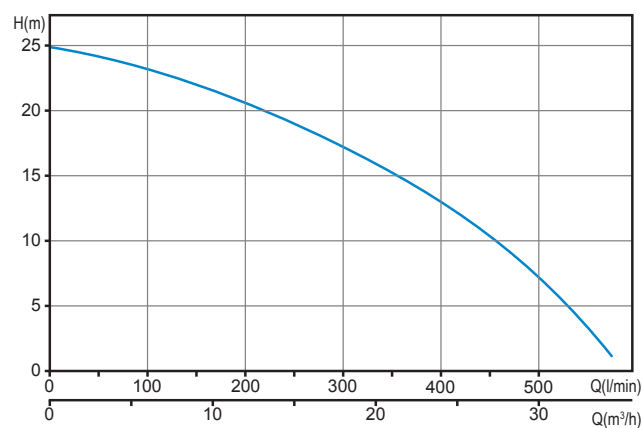

## Key to product code

DRE 50/2/G32V A0BM5

① ② ③ (A) (B) (C) ④ ⑤ ⑥ ⑦ ⑧ ⑨

- |                                |                                  |
|--------------------------------|----------------------------------|
| ① Family                       | ⑤ Hydraulic model                |
| ② Series                       | ⑥ Version number                 |
| ③ Power (HPx100) / motor poles | ⑦ Motor size                     |
| ④ Delivery rate                | ⑧ Motor phases                   |
| (A) TYPE (GAS thread/Flanged)  | M = Single-phase                 |
| (B) DIAMETER (mm)              | T = Three-phase                  |
| (C) POSITION                   | ⑨ Power supply voltage frequency |
| V = vertical                   | 5 = 50Hz                         |
| H = horizontal                 | 6 = 60Hz                         |

## Versions available

### • Electrical variants

#### Single-phase models

<b>TC</b>	Thermal protection, capacitor
<b>TCG</b>	Thermal protection, capacitor, float switch
<b>TCDT</b>	Thermal protection, capacitor, startup capacitor, overload protection
<b>TCDGT</b>	Thermal protection, capacitor, startup capacitor, float switch, overload protection

#### Three-phase models

<b>NAE</b>	No electric accessories installed
<b>TR</b>	Thermal protection, relay
<b>TRG</b>	Thermal protection, relay, float switch

### • Cooling system

<b>N</b>	No cooling and/or seal flushing system
----------	--

### • Set of mechanical seals

<b>SICM</b>	1 mechanical seal in silicon carbide and 1 lip seal
-------------	---

## Installations

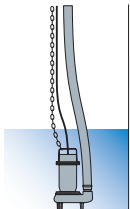

### Free installation

The electric pump, standing on its feet or base, is connected to the delivery flexible pipe using a joint fixed to the discharge. This installation allows to move easily the electrical pump

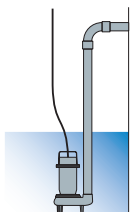

### Fixed installation

The electric pump, standing on its feet or base, is connected to the delivery pipe, which is screwed to the discharge if threaded, or fixed to a bend if the port is flanged. The pump-hose connection may be threaded or flanged, depending on the pump fitting.

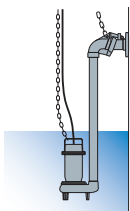

### Installation with external coupler

Available for electric pumps with threaded discharge. The pump unit is supported by a special device fitted to the delivery pipe. This device can be installed at any time without having to empty the tank. It simplifies any maintenance work on the pump, which can be lifted out and resubmerged with great ease. It is recommended in particular for installations of small size, and does not require the pump to be resting on the bottom of the tank.

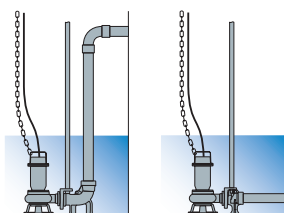

### Installation with base coupling foot

For submerged installation, available for electric pumps with flanged or threaded horizontal discharge. The coupling device is fixed to the bottom of the tank and the pump is lowered in with the aid of two guide pipes fitted earlier, until the connection to the foot is completed. The delivery pipe is fixed to the coupling device discharge. This device makes routine checks, any maintenance work or replacement of the pump extremely easy, with no need to empty the tank. A specific kit also allowing pumps with vertical discharge to be installed with the base coupling foot is available.

# DGE

## Pumps with vortex impeller

### Operating ranges

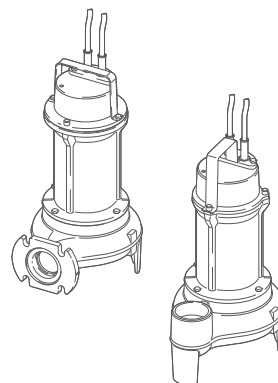
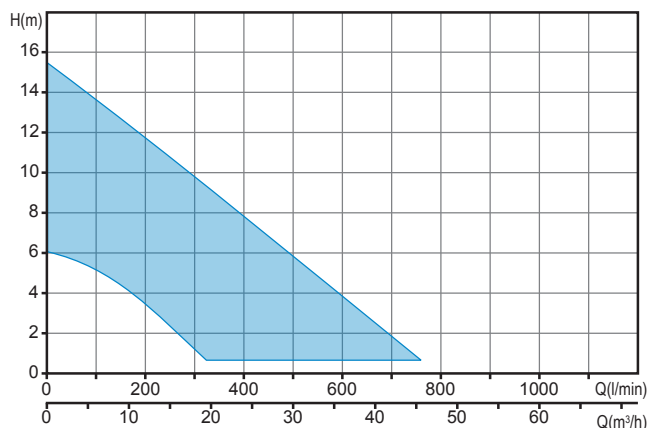

### Range characteristics

Motor power	0.37 ÷ 1.5 kW
Poles	2
Insulation class	F
Degree of protection	IP68
Discharge	GAS 2" vertical GAS 2" DN50 horizontal
Free passage	max 50 mm
Max flow rate	11.6 l/s (696 l/min)
Max head	15.7 m

### Motor

Dry motor with thermal protections.

### Cable

H07RN-F 4G1 - 5 m cable length. Optional 10 m cable length.

### Mechanical seals

One silicon carbide mechanical seal (SiC) and one lip seal (AL)

### Applications

Suitable with slightly soiled biological wastewaters and sewage. Suitable for domestic and residential use.

### Versions

Electrical variants	TC, TCG (single-phase models) NAE, TRG (three-phase models)
Cooling system	N
Mechanical seals	SICM

### Operating specifications

Max operating temperature	40 °C
PH of treated fluid	6 ÷ 14
Viscosity of treated fluid	1 mm²/s
Maximum immersion depth	20 m
Density of treated fluid	1 Kg/dm³
Acoustic pressure max	<70dB
Max starts per hour	30

### Construction materials

Case	Cast iron EN-GJL 250
Hydraulic parts	Cast iron EN-GJL 250
Impeller	Cast iron EN-GJL 250
Nuts and bolts	Stainless steel - Class A2-70
Standard gasket	Rubber - NBR
Shaft	Stainless steel - AISI 420
Paint type	Ecological bicomponent epoxy (~ 80 µm)

### Installations

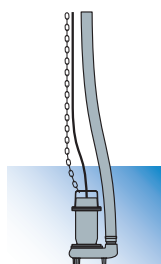

FREE

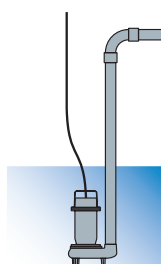

FIXED

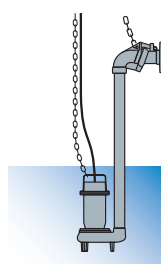

with EXTERNAL COUPLER

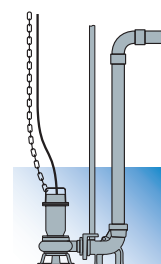

with BASE COUPLING FOOT

## DGE 2/G40V

### Performances

	l/s	0	2	4	6	8
	l/min	0	120	240	360	480
	m³/h	0	7.2	14.4	21.6	28.8
① DGE 100/2/G40V A0CM(T)5		13.7	11.1	7.9	3.7	
② DGE 150/2/G40V A0CM(T)5		15.9	13.1	9.8	5.7	
③ DGE 200/2/G40V A0CM(T)5		17.5	14.7	11.6	7.9	3.5

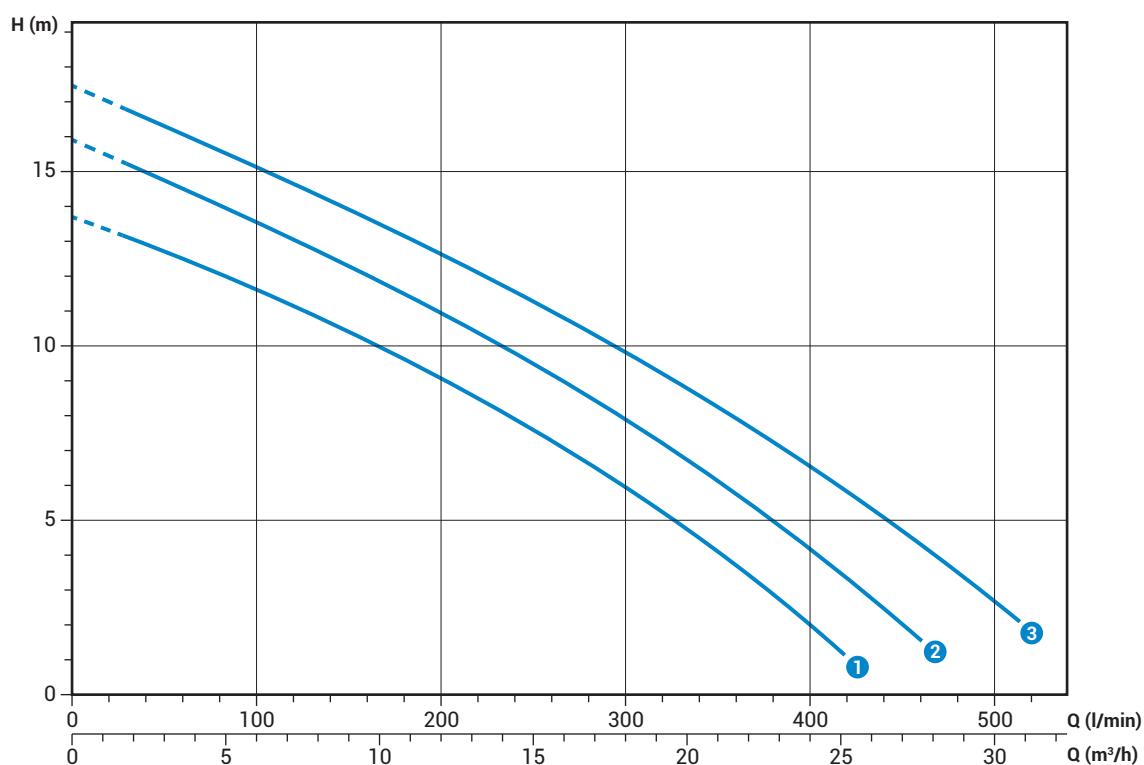

Characteristic curves according to UNI/EN ISO 9906

### Technical data

	V	Phases	P1 (kW)	P2 (kW)	A	Rpm	Start	Cable	Ø	Free passage
① DGE 100/2/G40V A0CM5	230	1	-	0.88	6.0	2900	Dir	3G1	G 1 ½"	40 mm
② DGE 150/2/G40V A0CM5	230	1	-	1.1	7.6	2900	Dir	3G1	G 1 ½"	40 mm
③ DGE 200/2/G40V A0CM5	230	1	-	1.5	8.9	2900	Dir	3G1	G 1 ½"	40 mm

	V	Phases	P1 (kW)	P2 (kW)	A	Rpm	Start	Cable	Ø	Free passage
① DGE 100/2/G40V A0CT5	400	3	-	0.88	2.0	2900	Dir	4G1	G 1 ½"	40 mm
② DGE 150/2/G40V A0CT5	400	3	-	1.1	2.5	2900	Dir	4G1	G 1 ½"	40 mm
③ DGE 200/2/G40V A0CT5	400	3	-	1.5	3.2	2900	Dir	4G1	G 1 ½"	40 mm



**DGE 2/G50V****Performances**

	l/s	0	2	4	6	8	10.0
	l/min	0	120	240	360	480	600
	m <sup>3</sup> /h	0	7.2	14.4	21.6	28.8	36.0
① DGE 50/2/G50V B0BM(T)5		6.1	4.9	2.6			
② DGE 75/2/G50V B0BM(T)5		8.0	6.7	4.7	2.0		
③ DGE 100/2/G50V B0CM(T)5		12.0	10.1	7.9	5.6	3.4	
④ DGE 150/2/G50V B0CM(T)5		13.9	11.9	9.6	7.2	4.8	2.4
⑤ DGE 200/2/G50V B0CM(T)5		15.7	13.6	11.2	8.8	6.3	3.9

Characteristic curves according to UNI/EN ISO 9906

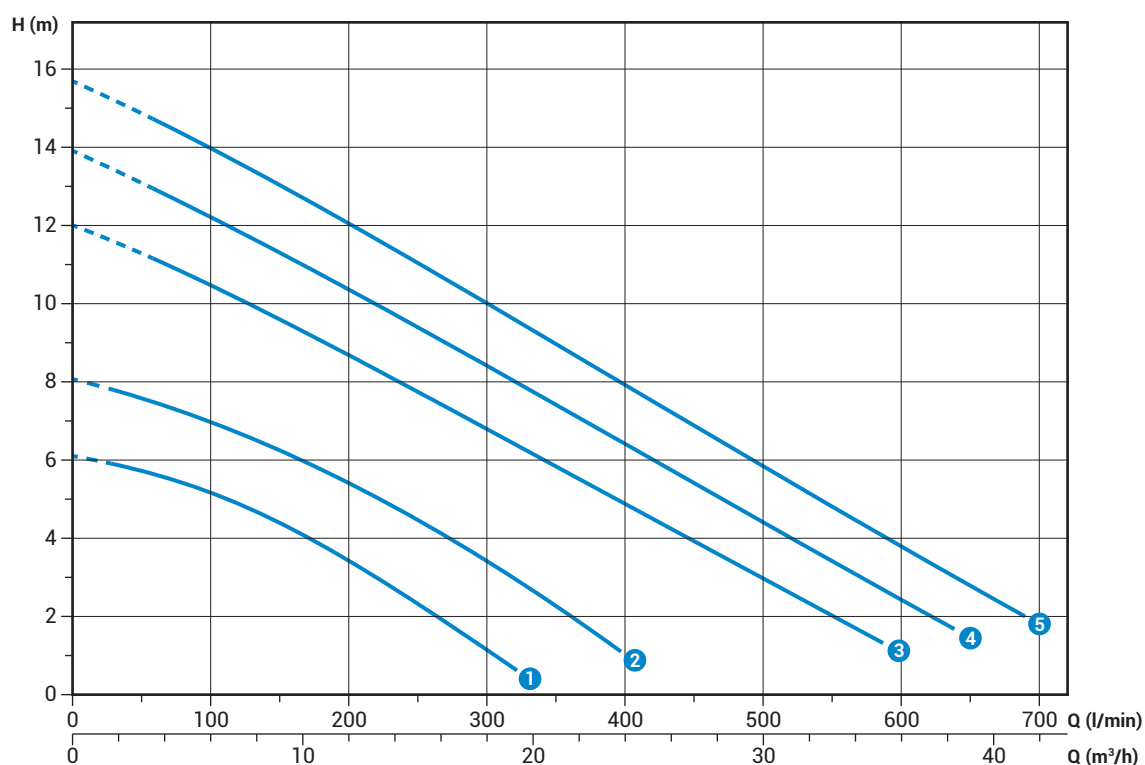
**Technical data**

	V	Phases	P1 (kw)	P2 (kw)	A	Rpm	Start	Cable	Ø	Free passage
① DGE 50/2/G50V B0BM5	230	1	-	0.37	2.8	2900	Dir	3G1	G 2"	40 mm
② DGE 75/2/G50V B0BM5	230	1	-	0.55	3.6	2900	Dir	3G1	G 2"	40 mm
③ DGE 100/2/G50V B0CM5	230	1	-	0.88	6.5	2900	Dir	3G1	G 2"	50 mm
④ DGE 150/2/G50V B0CM5	230	1	-	1.1	8.2	2900	Dir	3G1	G 2"	50 mm
⑤ DGE 200/2/G50V B0CM5	230	1	-	1.5	9.4	2900	Dir	3G1	G 2"	50 mm

	V	Phases	P1 (kw)	P2 (kw)	A	Rpm	Start	Cable	Ø	Free passage
① DGE 50/2/G50V B0BT5	400	3	-	0.37	1.1	2900	Dir	4G1	G 2"	40 mm
② DGE 75/2/G50V B0BT5	400	3	-	0.55	1.3	2900	Dir	4G1	G 2"	40 mm
③ DGE 100/2/G50V B0CT5	400	3	-	0.88	2.2	2900	Dir	4G1	G 2"	50 mm
④ DGE 150/2/G50V B0CT5	400	3	-	1.1	2.6	2900	Dir	4G1	G 2"	50 mm
⑤ DGE 200/2/G50V B0CT5	400	3	-	1.5	3.6	2900	Dir	4G1	G 2"	50 mm

# DGE 2/G50H

## Performances

	l/s	0	2	4	6	8	10
	l/min	0	120	240	360	480	600
	m <sup>3</sup> /h	0	7.2	14.4	21.6	28.8	36.0
① DGE 50/2/G50H A1BM(T)5		6.7	5.3	3.4	1.0		
② DGE 75/2/G50H A1BM(T)5		8.3	6.3	4.3	2.2		
③ DGE 100/2/G50H A0CM(T)5		12.6	10.2	7.8	5.3	2.8	
④ DGE 150/2/G50H A0CM(T)5		13.8	11.9	9.8	7.5	5.1	2.7
⑤ DGE 200/2/G50H A0CM(T)5		15.5	13.2	10.8	8.3	6.0	3.7

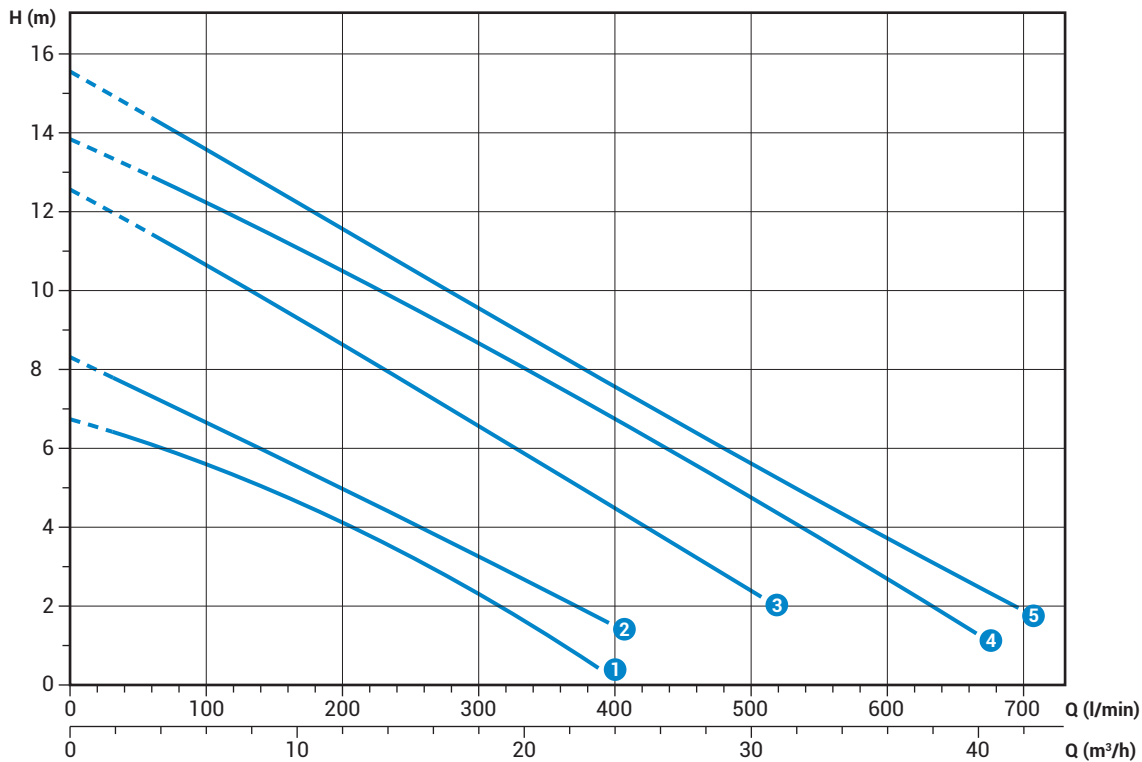

Characteristic curves according to UNI/EN ISO 9906

## Technical data

	V	Phases	P1 (kW)	P2 (kW)	A	Rpm	Start	Cable	Ø	Free passage
① DGE 50/2/G50H A1BM5	230	1	-	0.37	2.8	2900	Dir	3G1	G 2"- DN50	40 mm
② DGE 75/2/G50H A1BM5	230	1	-	0.55	3.6	2900	Dir	3G1	G 2"- DN50	40 mm
③ DGE 100/2/G50H A0CM5	230	1	-	0.88	6.5	2900	Dir	3G1	G 2"- DN50	50 mm
④ DGE 150/2/G50H A0CM5	230	1	-	1.1	8.2	2900	Dir	3G1	G 2"- DN50	50 mm
⑤ DGE 200/2/G50H A0CM5	230	1	-	1.5	9.4	2900	Dir	3G1	G 2"- DN50	50 mm

	V	Phases	P1 (kW)	P2 (kW)	A	Rpm	Start	Cable	Ø	Free passage
① DGE 50/2/G50H A1BT5	400	3	-	0.37	1.1	2900	Dir	4G1	G 2"- DN50	40 mm
② DGE 75/2/G50H A1BT5	400	3	-	0.55	1.3	2900	Dir	4G1	G 2"- DN50	40 mm
③ DGE 100/2/G50H A0CT5	400	3	-	0.88	2.2	2900	Dir	4G1	G 2"- DN50	50 mm
④ DGE 150/2/G50H A0CT5	400	3	-	1.1	2.6	2900	Dir	4G1	G 2"- DN50	50 mm
⑤ DGE 200/2/G50H A0CT5	400	3	-	1.5	3.6	2900	Dir	4G1	G 2"- DN50	50 mm

## Overall dimensions and weights

### Models with vertical discharge

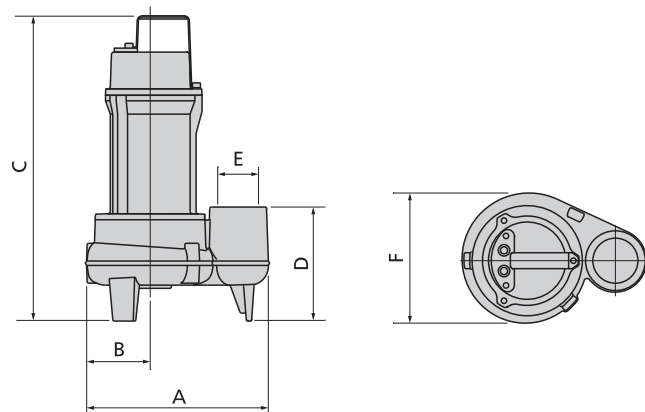

	A	B	C	D	E	F	kg
DGE 100/2/G40V A0CM(T)5	260	100	405	125	G 1½"	205	19
DGE 150/2/G40V A0CM(T)5	260	100	405	125	G 1½"	205	20
DGE 200/2/G40V A0CM(T)5	260	100	405	125	G 1½"	205	21
DGE 50/2/G50V B0BM(T)5	230	80	385	120	G 2"	165	12
DGE 75/2/G50V B0BM(T)5	230	80	385	120	G 2"	165	14
DGE 100/2/G50V B0CM(T)5	270	100	425	130	G 2"	205	19
DGE 150/2/G50V B0CM(T)5	270	100	425	130	G 2"	205	20
DGE 200/2/G50V B0CM(T)5	270	100	425	130	G 2"	205	21

Dimensions in mm

### Models with horizontal discharge

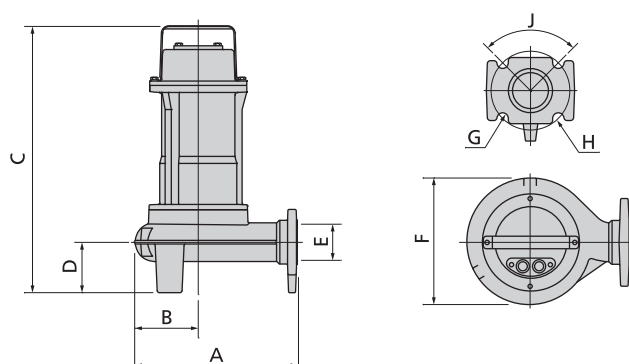

	A	B	C	D	E	F	G	H	J	kg
DGE 50/2/G50H A1BM(T)5	220	80	365	65	G 2" - DN50	160	18	125	90°	12
DGE 75/2/G50H A1BM(T)5	220	80	365	65	G 2" - DN50	160	18	125	90°	14
DGE 100/2/G50H A0CM(T)5	270	110	425	80	G 2" - DN50	205	18	125	90°	19
DGE 150/2/G50H A0CM(T)5	270	110	425	80	G 2" - DN50	205	18	125	90°	20
DGE 200/2/G50H A0CM(T)5	270	110	425	80	G 2" - DN50	205	18	125	90°	21

Dimensions in mm

## DGE

### Packaging dimension



	X	Y	Z
DGE 100/2/G40V A0CM(T)5	285	475	235
DGE 150/2/G40V A0CM(T)5	285	475	235
DGE 200/2/G40V A0CM(T)5	285	475	235
DGE 50/2/G50V B0BM(T)5	225	385	245
DGE 75/2/G50V B0BM(T)5	225	385	245
DGE 100/2/G50V B0CM(T)5	285	475	235
DGE 150/2/G50V B0CM(T)5	285	475	235
DGE 200/2/G50V B0CM(T)5	285	475	235
DGE 50/2/G50H A1BM(T)5	225	385	245
DGE 75/2/G50H A1BM(T)5	225	385	245
DGE 100/2/G50H A0CM(T)5	285	475	235
DGE 150/2/G50H A0CM(T)5	285	475	235
DGE 200/2/G50H A0CM(T)5	285	475	235

Dimensions in mm

## Pumps with multi-channel open impeller

### Operating ranges

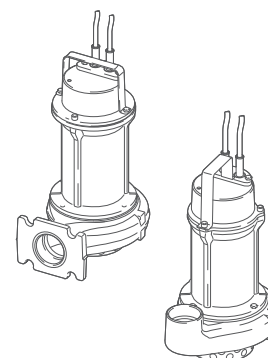
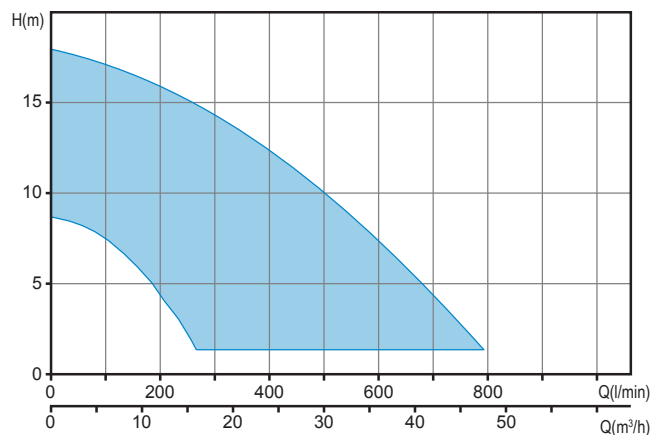

### Range characteristics

Motor power	0.37 ÷ 1.5 kW
Poles	2
Insulation class	F
Degree of protection	IP68
Discharge	GAS 1¼ ÷ 2" vertical GAS 2" DN50 horizontal
Free passage	max 15 mm
Max flow rate	12.6 l/s (756 l/min)
Max head	18.0 m

### Motor

Dry motor with thermal protections.

### Cable

H07RN-F 4G1 - 5 m cable length. Optional 10 m cable length.

### Mechanical seals

One silicon carbide mechanical seal (SiC) and one lip seal (AL).

### Applications

Can be used with clear or slightly soiled wastewaters containing small solids, strained water, rainwater, seepage and water pumped from underground.

### Versions

Electrical variants	TC, TCG (single-phase models) NAE, TRG (three-phase models)
Cooling system	N
Mechanical seals	SICM

### Operating specifications

Max operating temperature	40 °C
PH of treated fluid	6 ÷ 14
Viscosity of treated fluid	1 mm²/s
Maximum immersion depth	20 m
Density of treated fluid	1 Kg/dm³
Acoustic pressure max	<70dB
Max starts per hour	30

### Construction materials

Case	Cast iron EN-GJL 250
Hydraulic parts	Cast iron EN-GJL 250
Impeller	Cast iron EN-GJL 250
Nuts and bolts	Stainless steel - Class A2-70
Standard gasket	Rubber - NBR
Shaft	Stainless steel - AISI 420
Paint type	Ecological bicomponent epoxy (~ 80 µm)

### Installations

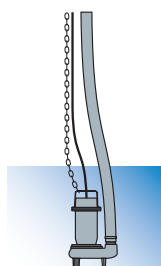

FREE

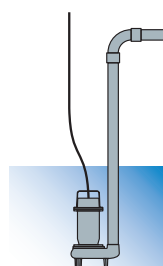

FIXED

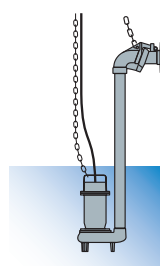

with EXTERNAL COUPLER

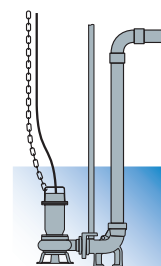

with BASE COUPLING FOOT

# DRE 2/G32V

## Performances

	l/s	0	1	2	3	4	5	6
	l/min	0	60	120	180	240	300	360
	m <sup>3</sup> /h	0	3.6	7.2	10.8	14.4	18.0	21.6
①	DRE 50/2/G32V A0BM(T)5	8.7	8.2	7.1	5.2	2.8		
②	DRE 75/2/G32V A0BM(T)5	12.2	11.6	10.6	9.0	6.9	4.2	1.1

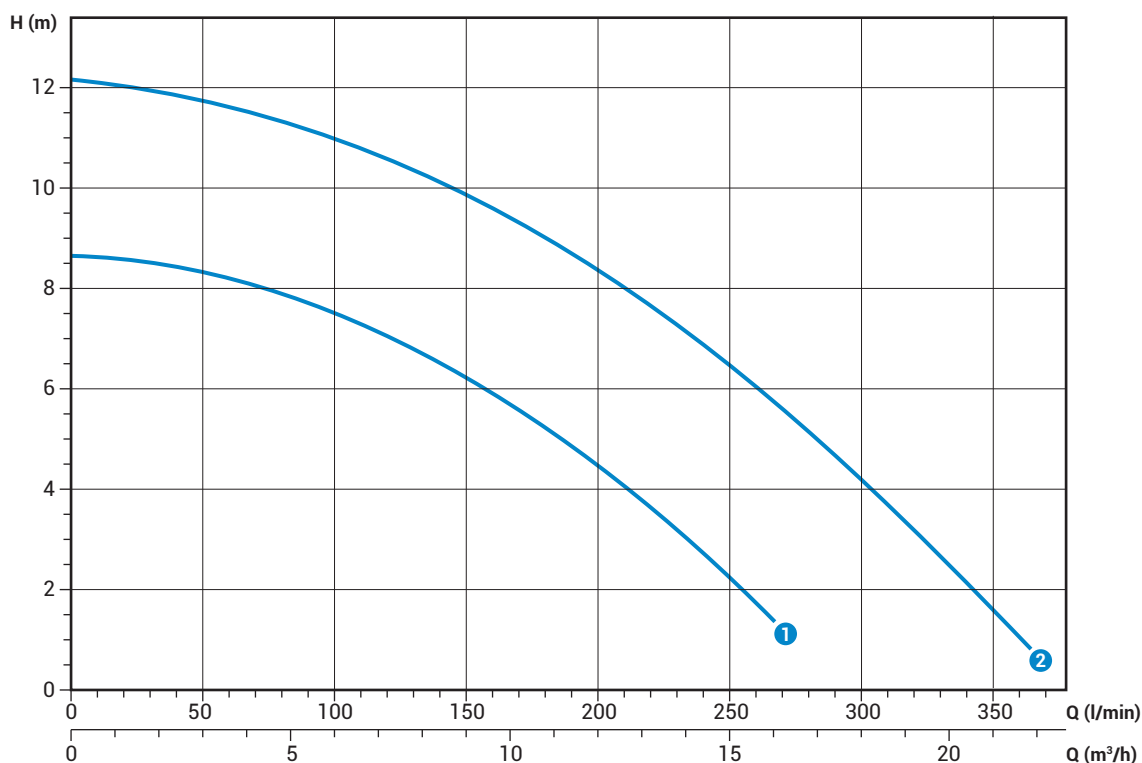

Characteristic curves according to UNI/EN ISO 9906

## Technical data

	V	Phases	P1 (kW)	P2 (kW)	A	Rpm	Start	Cable	Ø	Free passage	
①	DRE 50/2/G32V A0BM5	230	1	-	0.37	2.8	2900	Dir	3G1	G 1¼"	15 mm
②	DRE 75/2/G32V A0BM5	230	1	-	0.55	3.8	2900	Dir	3G1	G 1¼"	15 mm

	V	Phases	P1 (kW)	P2 (kW)	A	Rpm	Start	Cable	Ø	Free passage	
①	DRE 50/2/G32V A0BT5	400	3	-	0.37	1.1	2900	Dir	4G1	G 1¼"	15 mm
②	DRE 75/2/G32V A0BT5	400	3	-	0.55	1.3	2900	Dir	4G1	G 1¼"	15 mm

**DRE 2/G50V****Performances**

	I/s	0	2	4	6	8	10	12
	l/min	0	120	240	360	480	600	720
	m <sup>3</sup> /h	0	7.2	14.4	21.6	28.8	36	43.2
① DRE 100/2/G50V A0CM(T)5		12.4	11.6	10.0	7.8	4.9		
② DRE 150/2/G50V A0CM(T)5		14.5	13.7	12.1	9.9	7.0	3.4	
③ DRE 200/2/G50V A0CM(T)5		18.0	17.0	15.4	13.3	10.7	7.6	3.9

Characteristic curves according to UNI/EN ISO 9906

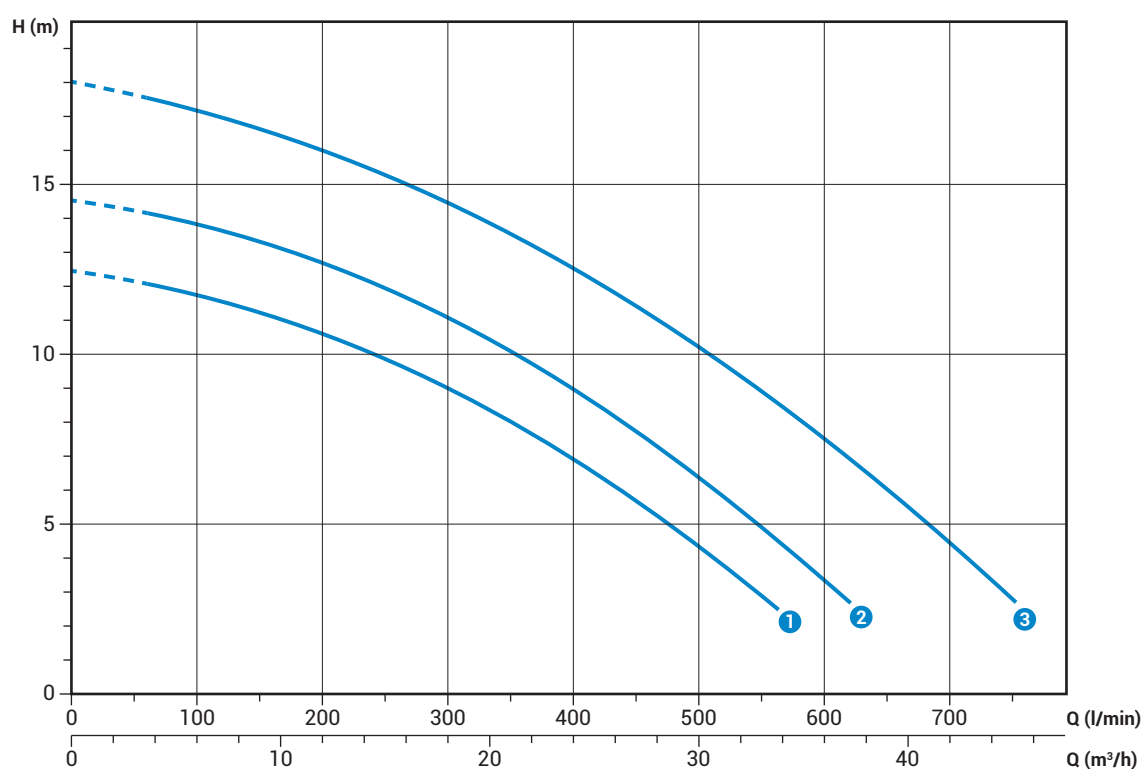
**Technical data**

	V	Phases	P1 (kW)	P2 (kW)	A	Rpm	Start	Cable	Ø	Free passage
① DRE 100/2/G50V A0CM5	230	1	-	0.88	6.5	2900	Dir	3G1	G 2"	15 mm
② DRE 150/2/G50V A0CM5	230	1	-	1.1	8.2	2900	Dir	3G1	G 2"	15 mm
③ DRE 200/2/G50V A0CM5	230	1	-	1.5	9.3	2900	Dir	3G1	G 2"	15 mm

	V	Phases	P1 (kW)	P2 (kW)	A	Rpm	Start	Cable	Ø	Free passage
① DRE 100/2/G50V A0CT5	400	3	-	0.88	2.3	2900	Dir	4G1	G 2"	15 mm
② DRE 150/2/G50V A0CT5	400	3	-	1.1	2.7	2900	Dir	4G1	G 2"	15 mm
③ DRE 200/2/G50V A0CT5	400	3	-	1.5	3.5	2900	Dir	4G1	G 2"	15 mm

# DRE 2/G50H

## Performances

	0	2	4	6	8	10	12
I/s	0	2	4	6	8	10	12
l/min	0	120	240	360	480	600	720
m <sup>3</sup> /h	0	7.2	14.4	21.6	28.8	36	43.2
① DRE 100/2/G50H A0CM(T)5	12.4	11.6	10.0	7.8	4.9		
② DRE 150/2/G50H A0CM(T)5	14.5	13.7	12.1	9.9	7.0	3.4	
③ DRE 200/2/G50H A0CM(T)5	18.0	17.0	15.4	13.3	10.7	7.6	3.9

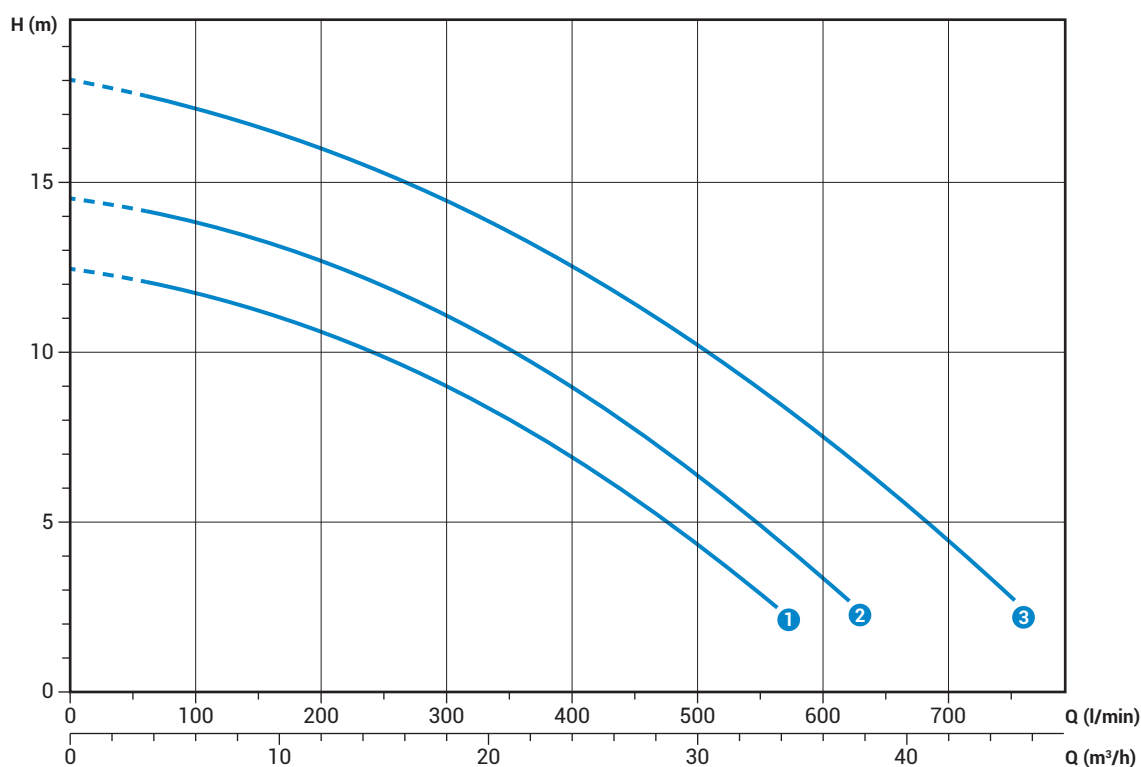

Characteristic curves according to UNI/EN ISO 9906

## Technical data

	V	Phases	P1 (kW)	P2 (kW)	A	Rpm	Start	Cable	Ø	Free passage
① DRE 100/2/G50H A0CM5	230	1	-	0.88	6.5	2900	Dir	3G1	G 2"	15 mm
② DRE 150/2/G50H A0CM5	230	1	-	1.1	8.2	2900	Dir	3G1	G 2"	15 mm
③ DRE 200/2/G50H A0CM5	230	1	-	1.5	9.3	2900	Dir	3G1	G 2"	15 mm

	V	Phases	P1 (kW)	P2 (kW)	A	Rpm	Start	Cable	Ø	Free passage
① DRE 100/2/G50H A0CT5	400	3	-	0.88	2.3	2900	Dir	4G1	G 2"	15 mm
② DRE 150/2/G50H A0CT5	400	3	-	1.1	2.7	2900	Dir	4G1	G 2"	15 mm
③ DRE 200/2/G50H A0CT5	400	3	-	1.5	3.5	2900	Dir	4G1	G 2"	15 mm



## Overall dimensions and weights

### Models with vertical discharge

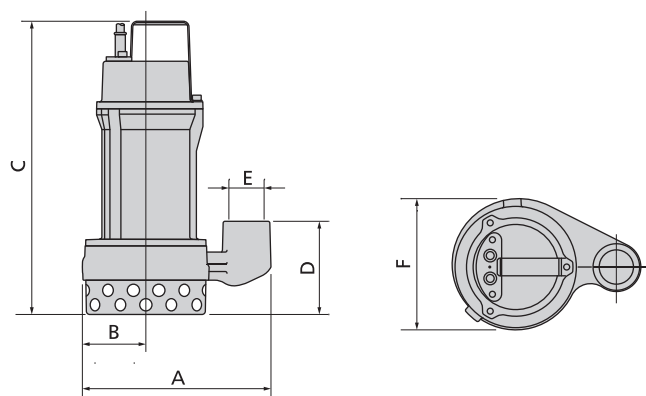

### Models with horizontal discharge

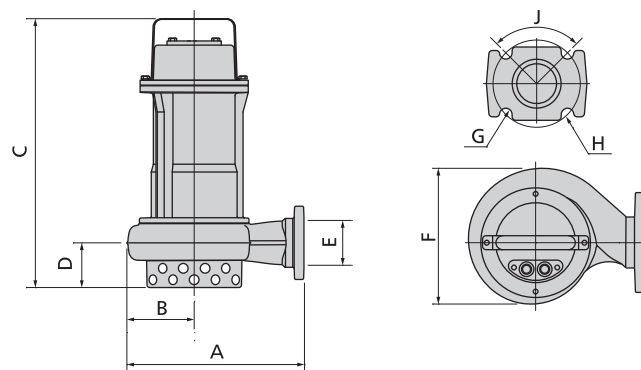

	A	B	C	D	E	F	kg
DRE 50/2/G32V A0BM(T)5	215	70	335	105	G 1 1/4"	150	11
DRE 75/2/G32V A0BM(T)5	215	70	335	105	G 1 1/4"	150	13
DRE 100/2/G50V A0CM(T)5	265	100	385	125	G 2"	190	19
DRE 150/2/G50V A0CM(T)5	265	100	385	125	G 2"	190	20
DRE 200/2/G50V A0CM(T)5	265	100	385	125	G 2"	190	21

Dimensions in mm

	A	B	C	D	E	F	G	H	J	kg
DRE 100/2/G50H A0CM(T)5	255	95	385	65	G 2"-DN50	195	18	125	90°	19
DRE 150/2/G50H A0CM(T)5	255	95	385	65	G 2"-DN50	195	18	125	90°	20
DRE 200/2/G50H A0CM(T)5	255	95	385	65	G 2"-DN50	195	18	125	90°	21

Dimensions in mm

### Packaging dimension



	X	Y	C
DRE 50/2/G32V A0BM(T)5	385	225	245
DRE 75/2/G32V A0BM(T)5	385	225	245
DRE 100/2/G50V A0CM(T)5	475	285	235
DRE 150/2/G50V A0CM(T)5	475	285	235
DRE 200/2/G50V A0CM(T)5	475	285	235
DRE 100/2/G50H A0CM(T)5	475	285	235
DRE 150/2/G50H A0CM(T)5	475	285	235
DRE 200/2/G50H A0CM(T)5	475	285	235

Dimensions in mm

## GRE

## Pumps with grinder impeller

## Operating ranges

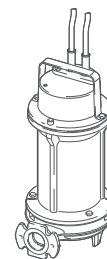
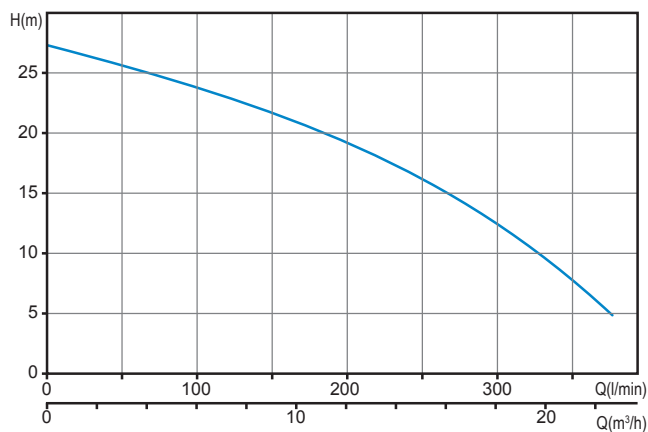

## Range characteristics

Motor power	1.5 kW
Poles	2
Insulation class	F
Degree of protection	IP68
Discharge	GAS 2" DN32 horizontal
Free passage	-
Max flow rate	6.3 l/s (378 l/min)
Max head	27.3 m

## Motor

Dry motor with thermal protections.

## Cable

H07RN-F 4G1 - 5 m cable length. Optional 10 m cable length.

## Mechanical seals

One silicon carbide mechanical seal (SiC) and one lip seal (AL)

## Applications

Suitable for lifting soiled wastewaters containing filaments or fibres, and unstrained household sewage in general.

## Installations

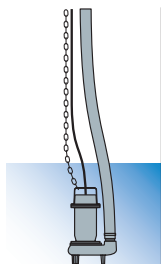

FREE

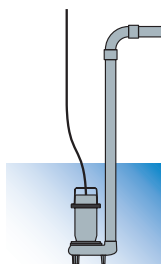

FIXED

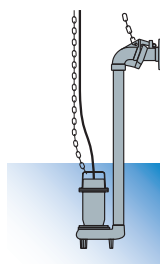

with EXTERNAL COUPLER

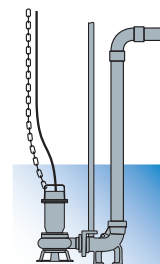

with BASE COUPLING FOOT

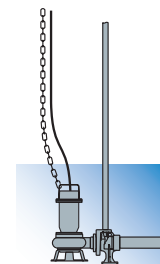

## Versions

Electrical variants	TCDT, TCDGT (single-phase models) TR, TRG (three-phase models)
Cooling system	N
Mechanical seals	SICM

## Operating specifications

Max operating temperature	40 °C
PH of treated fluid	6 ÷ 14
Viscosity of treated fluid	1 mm²/s
Maximum immersion depth	20 m
Density of treated fluid	1 Kg/dm³
Acoustic pressure max	<70dB
Max starts per hour	30

## Construction materials

Case	Cast iron EN-GJL 250
Hydraulic parts	Cast iron EN-GJL 250
Impeller	Cast iron EN-GJL 250
Nuts and bolts	Stainless steel - Class A2-70
Standard gasket	Rubber - NBR
Shaft	Stainless steel - AISI 420
Grinding system	Chromium steel
Paint type	Ecological bicomponent epoxy (~ 80 µm)

## GRE 2/G50H

## Performances

	l/s	0	1	2	3	4	5	6
	l/min	0	60	120	180	240	300	360
	m <sup>3</sup> /h	0	3.6	7.2	10.8	14.4	18.0	21.6
① GRE 200/2/G50H A0CM(T)5		27.3	25.2	22.9	20.2	16.8	12.4	6.6

Characteristic curves according to UNI/EN ISO 9906

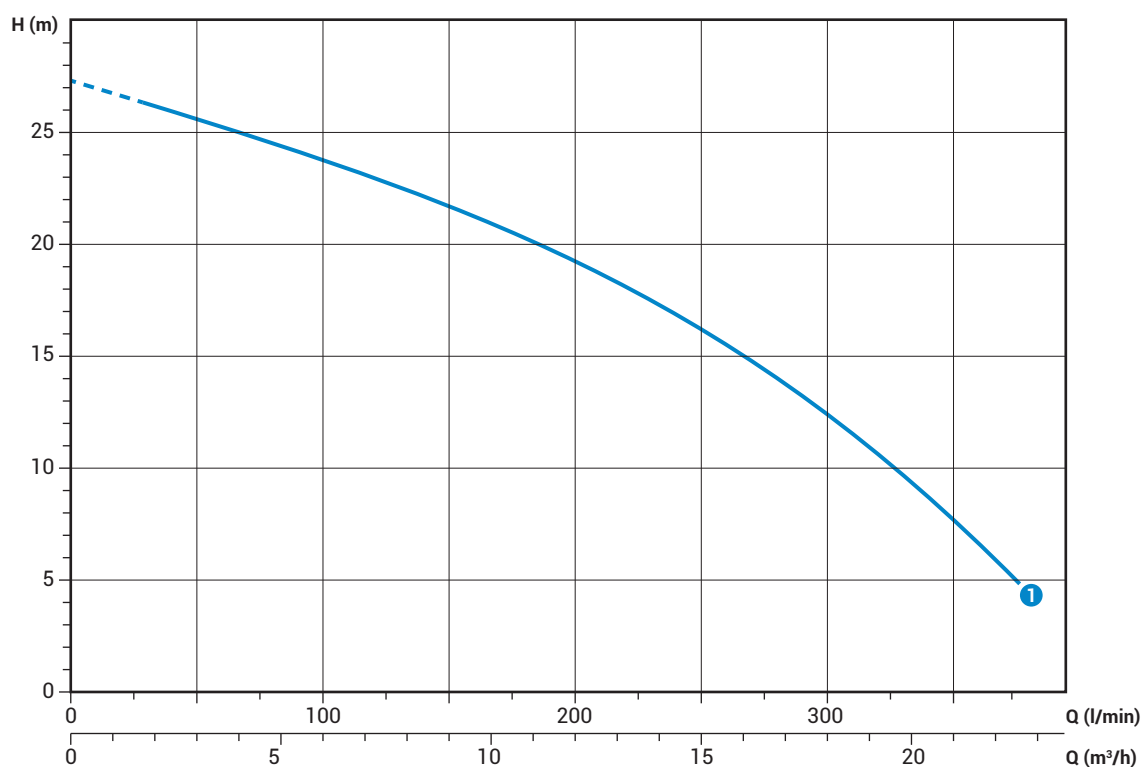

## Technical data

	V	Phases	P1 (kW)	P2 (kW)	A	Rpm	Start	Cable	Ø	Free passage
① GRE 200/2/G50H A0CM5	230	1	-	1.7	10.6	2900	Dir	4G1	G 2" - DN32	-

	V	Phases	P1 (kW)	P2 (kW)	A	Rpm	Start	Cable	Ø	Free passage
① GRE 200/2/G50H A0CT5	400	3	-	1.7	3.8	2900	Dir	4G1	G 2" - DN32	-

## GRE

## Overall dimensions and weights

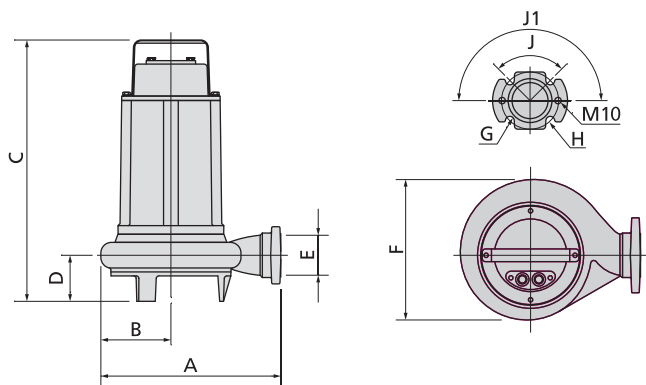

	A	B	C	D	E	F	G	H	J	J1	kg
GRE 200/2/G50H AOCM(T)5	285	110	410	75	G 2"-DN32	220	14	90	90°	180°	26

Dimensions in mm

## Packaging dimension



	X	Y	C
GRE 200/2/G50H AOCM(T)5	285	475	235

Dimensions in mm

## Pumps with high head impeller

### Operating ranges

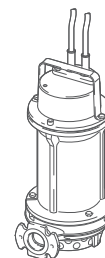
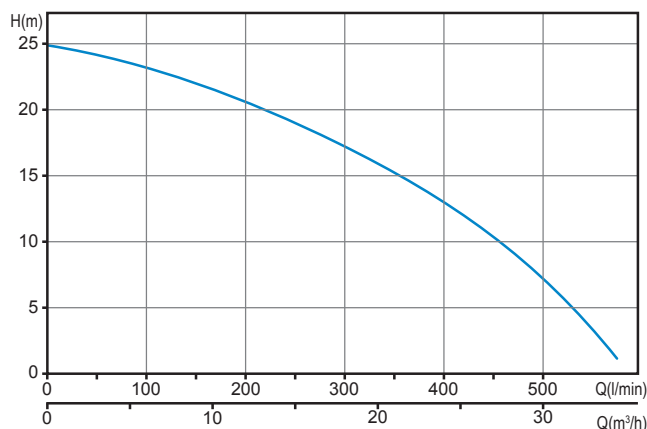

### Range characteristics

Motor power	1.5 kW
Poles	2
Insulation class	F
Degree of protection	IP68
Discharge	GAS 2" DN32 horizontal
Free passage	7 mm
Max flow rate	9.5 l/s (570 l/min)
Max head	24.9 m

### Motor

Dry motor with thermal protections.

### Cable

H07RN-F 4G1 - 5 m cable length. Optional 10 m cable length.

### Mechanical seals

One silicon carbide mechanical seal (SiC) and one lip seal (AL)

### Applications

Used for clear wastewater, rainwater and seepage containing small amounts of sand. The considerable manometric head makes these units suitable for irrigation and the fish processing sector.

### Versions

Electrical variants	TC, TCG (single-phase models) TR, TRG (three-phase models)
Cooling system	N
Mechanical seals	SICM

### Operating specifications

Max operating temperature	40 °C
PH of treated fluid	6 ÷ 14
Viscosity of treated fluid	1 mm²/s
Maximum immersion depth	20 m
Density of treated fluid	1 Kg/dm³
Acoustic pressure max	<70dB
Max starts per hour	30

### Construction materials

Case	Cast iron EN-GJL 250
Hydraulic parts	Cast iron EN-GJL 250
Impeller	Cast iron EN-GJL 250
Nuts and bolts	Stainless steel - Class A2-70
Standard gasket	Rubber - NBR
Shaft	Stainless steel - AISI 420
Paint type	Ecological bicomponent epoxy (~ 80 µm)

### Installations

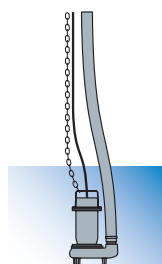

FREE

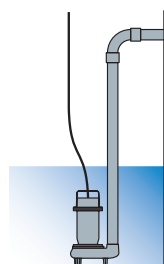

FIXED

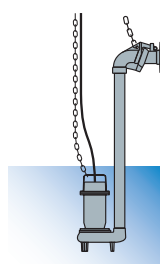

with EXTERNAL COUPLER

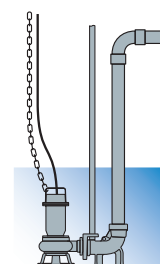

with BASE COUPLING FOOT

# APE 2/G50H

## Performances

	0	1	2	3	4	5	6	7	8	9
l/s	0	60	120	180	240	300	360	420	480	540
l/min	0	3.6	7.2	10.8	14.4	18.0	21.6	25.2	28.8	32.4
m <sup>3</sup> /h	0	24.9	23.9	22.7	21.2	19.3	17.2	14.8	11.9	8.5
① APE 200/2/G50H A0CM(T)5	24.9	23.9	22.7	21.2	19.3	17.2	14.8	11.9	8.5	4.0

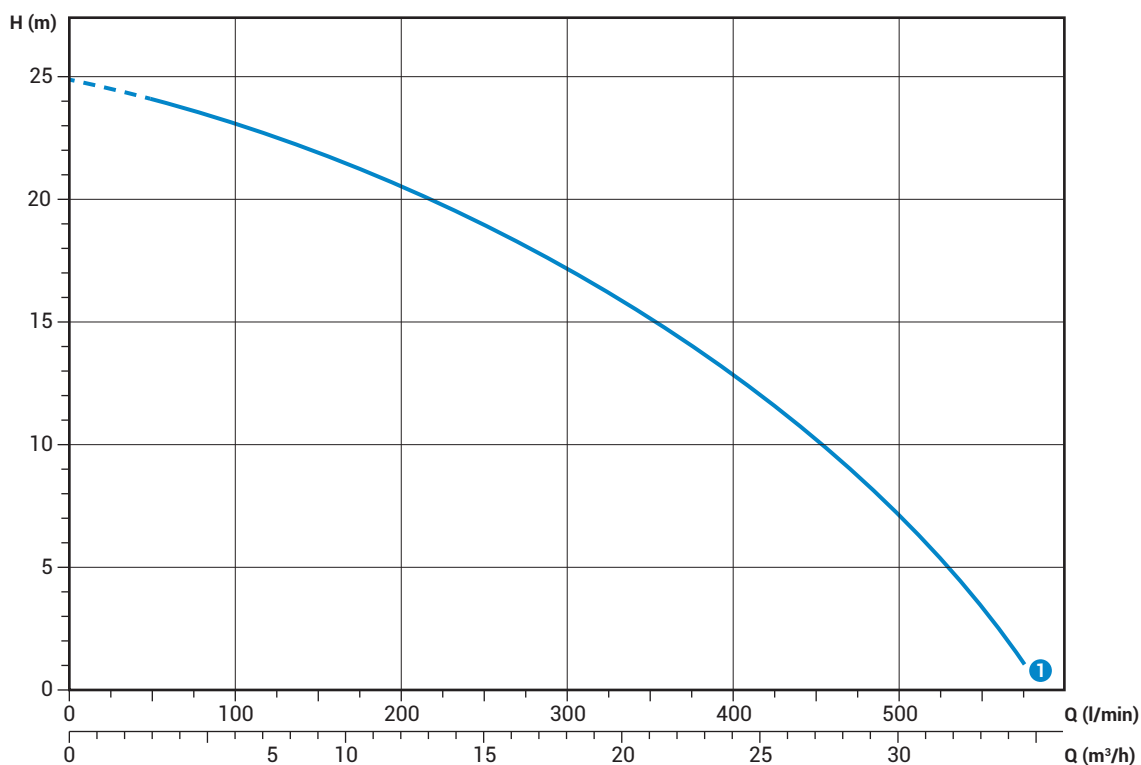

Characteristic curves according to UNI EN ISO 9906

## Technical data

	V	Phases	P1 (kW)	P2 (kW)	A	Rpm	Start	Cable	Ø	Free passage
① APE 200/2/G50H A0CM5	230	1	-	1.7	10.6	2900	Dir	3G1	G 2" - DN32	7 mm

	V	Phases	P1 (kW)	P2 (kW)	A	Rpm	Start	Cable	Ø	Free passage
① APE 200/2/G50H A0CT5	400	3	-	1.7	3.8	2900	Dir	4G1	G 2" - DN32	7 mm

## Overall dimensions and weights

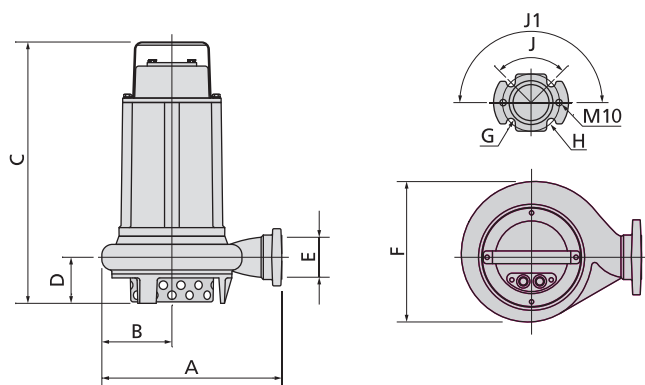

	A	B	C	D	E	F	G	H	J	J1	kg
APE 200/2/G50H AOCM(T)5	285	110	410	75	G 2"-DN50	220	14	90	90°	180°	26

Dimensions in mm

## Packaging dimension



	X	Y	C
APE 200/2/G50H AOCM(T)5	285	475	235

Dimensions in mm

## Hydraulic performance data

For quick, easy reference

### DGE

	I/s	0	2	4	6	8	10
	l/min	0	120	240	360	480	600
	m <sup>3</sup> /h	0	7.2	14.4	21.6	28.8	36
DGE 100/2/G40V A0CM(T)5		13.7	11.1	7.9	3.7		
DGE 150/2/G40V A0CM(T)5		15.9	13.1	9.8	5.7		
DGE 200/2/G40V A0CM(T)5		17.5	14.7	11.6	7.9	3.5	
DGE 50/2/G50V B0BM(T)5		6.1	4.9	2.6			
DGE 75/2/G50V B0BM(T)5		8.0	6.7	4.7	2.0		
DGE 100/2/G50V B0CM(T)5		12.0	10.1	7.9	5.6	3.4	
DGE 150/2/G50V B0CM(T)5		13.9	11.9	9.6	7.2	4.8	2.4
DGE 200/2/G50V B0CM(T)5		15.7	13.6	11.2	8.8	6.3	3.9
DGE 50/2/G50H A1BM(T)5		6.7	5.3	3.4	1.0		
DGE 75/2/G50H A1BM(T)5		8.3	6.3	4.3	2.2		
DGE 100/2/G50H A0CM(T)5		12.6	10.2	7.8	5.3	2.8	
DGE 150/2/G50H A0CM(T)5		13.8	11.9	9.8	7.5	5.1	2.7
DGE 200/2/G50H A0CM(T)5		15.5	13.2	10.8	8.3	6.0	3.7

### DRE

	I/s	0	2	4	6	8	10	12
	l/min	0	120	240	360	480	600	720
	m <sup>3</sup> /h	0	7.2	14.4	21.6	28.8	36	43.2
DRE 50/2/G32V A0BM(T)5		8.7	7.1	2.8				
DRE 75/2/G32V A0BM(T)5		12.2	10.6	6.9	1.1			
DRE 100/2/G50V A0CM(T)5		12.4	11.6	10.0	7.8	4.9		
DRE 150/2/G50V A0CM(T)5		14.5	13.7	12.1	9.9	7.0	3.4	
DRE 200/2/G50V A0CM(T)5		18.0	17.0	15.4	13.3	10.7	7.6	3.9
DRE 100/2/G50H A0CM(T)5		12.4	11.6	10.0	7.8	4.9		
DRE 150/2/G50H A0CM(T)5		14.5	13.7	12.1	9.9	7.0	3.4	
DRE 200/2/G50H A0CM(T)5		18.0	17.0	15.4	13.3	10.7	7.6	3.9

### GRE

	I/s	0	1	2	3	4	5	6
	l/min	0	60	120	180	240	300	360
	m <sup>3</sup> /h	0	3.6	7.2	10.8	14.4	18.0	21.6
GRE 200/2/G50H A0CM(T)5		27.3	25.2	22.9	20.2	16.8	12.4	6.6

### APE

	I/s	0	1	2	3	4	5	6	7	8	9
	l/min	0	60	120	180	240	300	360	420	480	540
	m <sup>3</sup> /h	0	3.6	7.2	10.8	14.4	18.0	21.6	25.2	28.8	32.4
APE 200/2/G50H A0CM(T)5		24.9	23.9	22.7	21.2	19.3	17.2	14.8	11.9	8.5	4.0











water solutions

All data made available remain non-binding.  
Zenit reserves the right to make unannounced product changes it deems appropriate.

Rev. 1 - 07/02/17