

4" SUPER STAINLESS MOTOR - 3-PHASE DESIGN



FEATURES & BENEFITS

- 4" NEMA mounting design with metric studs
- Stainless steel splined shaft
- Stator shell in 316SS
- Factory filled with Franklin's non-toxic water soluble fill solution
- Max. storage temperature -15°C - + 50°C
- Liquid lubricated radial bearings and High capacity Kingsbury type thrust bearing for 100 % maintenance free operation
- Field replaceable lead using Franklin's exclusive Water Bloc technology with extended jam nut in Stainless steel
- High efficiency electrical design for low operation costs
- Drinking water approvals
- Suitable for use in water with increased salinity

SPECIFICATION

- Ratings: 0.25 - 3.0 kW
- Frequency: 50 Hz ; 60 Hz
- Thrust load: 4 kN
- Nominal ambient temperature: 30 °C with 0.08 m/s cooling flow
- Voltage tolerance: -10 % / +6 % (50 Hz), +/- 10% (60 Hz)
- Protection IP68, insulation class B
- Frequency of starts: 20 starts/ hour (with min. 3 minutes resting time)
- All motors with factory installed leads (1.50 m / 2.50 m)
- Installation orientation: Vertical / horizontal (shaft end heightened)
- Rotation counter clock wise facing shaft end (3 phase motors rotation reversible)

Pollution Recovery version:

- Fluorelastomere (Viton®) rubber parts
- Special Polyuretane (PUR) lead assemblies
- 304SS (316SS Stator) graded Stainless Steel as Standard



OPTIONS

- Built in lightning arrestors
- 316SS material design
- Special lead lengths



ISO 9001

All motors are manufactured in ISO 9001 certified plants and 100% tested



Hydrodynamic liquid lubricated radial bearings

100 % maintenance free operation

StatorSHIELD™ - Franklin encapsulation system

Franklin Electric encapsulated motors are equipped with hermetically-sealed windings. The Anti track stator resin mechanically supports the winding and provides fast heat dissipation.

Kingsbury type thrust bearing

High capacity 4 kN Kingsbury type thrust bearing for 100 % maintenance free operation

Pressure-equalizing diaphragm



4" SUPER STAINLESS MOTOR - 3-PHASE DESIGN

MOTOR MODEL NUMBERS 50 HZ - 3-PHASE DESIGN

P _N [kW]	U _N [V]	Digit 1 - 6	Digit 7 - 10							
			Standard 304SS		Pollution Recovery 304SS		Standard 316SS		Pollution Recovery 316SS	
			Single pack, with lead*	40 motors packing unit	Single pack, with lead*	40 motors packing unit	Single pack, with lead*	40 motors packing unit	Single pack, with lead*	40 motors packing unit
0,37	220, 230	234 751	6721L	6721	6723L	6723	6821L	6821	6823L	6823
	380 - 415	234 761	6721L	6721	6723L	6723	6821L	6821	6823L	6823
	500	234 791	6721L	6721	6723L	6723	6821L	6821	6823L	6823
0,55	220, 230	234 752	6721L	6721	6723L	6723	6821L	6821	6823L	6823
	380 - 415	234 762	6721L	6721	6723L	6723	6821L	6821	6823L	6823
	500	234 792	6721L	6721	6723L	6723	6821L	6821	6823L	6823
0,75	220, 230	234 753	6721L	6721	6723L	6723	6821L	6821	6823L	6823
	380 - 415	234 763	6721L	6721	6723L	6723	6821L	6821	6823L	6823
	500	234 793	6721L	6721	6723L	6723	6821L	6821	6823L	6823
1,10	220, 230	234 754	6721L	6721	6723L	6723	6821L	6821	6823L	6823
	380 - 415	234 724	6721L	6721	6723L	6723	6821L	6821	6823L	6823
	500	234 794	6721L	6721	6723L	6723	6821L	6821	6823L	6823
1,50	220, 230	234 755	6721L	6721	6723L	6723	6821L	6821	6823L	6823
	380 - 415	234 725	6721L	6721	6723L	6723	6821L	6821	6823L	6823
	500	234 795	6721L	6721	6723L	6723	6821L	6821	6823L	6823
2,20	220, 230	234 756	6721L	6721	6723L	6723	6821L	6821	6823L	6823
	380 - 415	234 726	6721L	6721	6723L	6723	6821L	6821	6823L	6823
	500	234 796	6721L	6721	6723L	6723	6821L	6821	6823L	6823
3,00	220, 230	234 766	6721L	6721	6723L	6723	6821L	6821	6823L	6823
	380 - 415	234 764	6721L	6721	6723L	6723	6821L	6821	6823L	6823
	500	234 768	6721L	6721	6723L	6723	6821L	6821	6823L	6823

* lead lengths motors: „L“: up to 1.5 kW with 1.50 m preassembled cable, starting at 2.2 kW with 2.50 m pre-mounted cable

4" SUPER STAINLESS MOTOR - 3-PHASE DESIGN

MOTOR MODEL NUMBERS 60 HZ - 3-PHASE DESIGN

P _N [kW]	P _{MAX} [kW]	U _N [V]	Digit 1 - 6	Digit 7 - 10							
				Standard 304SS		Pollution Recovery 304SS		Standard 316SS		Pollution Recovery 316SS	
				Single pack, with lead*	40 motors packing unit	Single pack, with lead*	40 motors packing unit	Single pack, with lead*	40 motors packing unit	Single pack, with lead*	40 motors packing unit
0,37	0,59	220	234 711	6721L	6721	6723L	6723	6821L	6821	6823L	6823
		380	234 741	6721L	6721	6723L	6723	6821L	6821	6823L	6823
		460	234 761	6721L	6721	6723L	6723	6821L	6821	6823L	6823
0,55	0,83	220	234 712	6721L	6721	6723L	6723	6821L	6821	6823L	6823
		230	234 742	6721L	6721	6723L	6723	6821L	6821	6823L	6823
		460	234 762	6721L	6721	6723L	6723	6821L	6821	6823L	6823
0,75	1	220	234 713	6721L	6721	6723L	6723	6821L	6821	6823L	6823
		380	234 743	6721L	6721	6723L	6723	6821L	6821	6823L	6823
		460	234 763	6721L	6721	6723L	6723	6821L	6821	6823L	6823
1,10	1,4	220	234 714	6721L	6721	6723L	6723	6821L	6821	6823L	6823
		230	234 744	6721L	6721	6723L	6723	6821L	6821	6823L	6823
		460	234 724	6721L	6721	6723L	6723	6821L	6821	6823L	6823
1,50	1,8	220	234 715	6721L	6721	6723L	6723	6821L	6821	6823L	6823
		380	234 745	6721L	6721	6723L	6723	6821L	6821	6823L	6823
		460	234 725	6721L	6721	6723L	6723	6821L	6821	6823L	6823
2,20	2,5	220	234 716	6721L	6721	6723L	6723	6821L	6821	6823L	6823
		230	234 746	6721L	6721	6723L	6723	6821L	6821	6823L	6823
		460	234 726	6721L	6721	6723L	6723	6821L	6821	6823L	6823
3,00	3,4	220	234 776	6721L	6721	6723L	6723	6821L	6821	6823L	6823
		380	234 774	6721L	6721	6723L	6723	6821L	6821	6823L	6823
		460	234 764	6721L	6721	6723L	6723	6821L	6821	6823L	6823

* lead lengths motors: „L“: up to 1.5 kW with 1.50 m preassembled cable, starting at 2.2 kW with 2.50 m pre-mounted cable

4" SUPER STAINLESS MOTOR - 3-PHASE DESIGN

MOTOR PERFORMANCE DATA 50 HZ - 3-PHASE DESIGN

P _N [kW]	Thrust F [N]	U _N [V]	n _N [min ⁻¹]	I _N [A]	I _A [A]	η (Eff.) [%] at % load			cos φ (Pf.) at % load			T _N [Nm]	T _A [Nm]
						50	75	100	50	75	100		
0,37	4000	220	2850	1,91	8,83	55	63	66	0,60	0,71	0,79	1,23	2,70
		230	2870	1,90	9,36	54	63	66	0,55	0,66	0,74	1,22	3,00
		380	2850	1,10	5,10	55	63	66	0,60	0,71	0,79	1,23	2,70
		400	2870	1,10	5,41	54	63	66	0,55	0,66	0,74	1,22	3,00
		415	2880	1,14	5,61	53	61	65	0,51	0,62	0,71	1,23	3,20
		500	2830	0,84	3,88	55	63	68	0,60	0,71	0,79	1,23	2,70
0,55	4000	220	2855	2,7	12,2	57	64	68	0,60	0,71	0,79	1,84	3,80
		230	2870	2,8	12,9	55	63	68	0,53	0,65	0,74	1,82	4,20
		380	2855	1,6	7,0	57	64	68	0,60	0,71	0,79	1,84	3,80
		400	2870	1,6	7,4	55	63	68	0,53	0,65	0,74	1,82	4,20
		415	2880	1,7	7,7	50	60	65	0,50	0,61	0,70	1,82	4,60
		500	2855	1,2	5,3	57	64	68	0,60	0,71	0,79	1,84	3,80
0,75	4000	220	2840	3,5	17,4	63	69	70	0,61	0,73	0,81	2,51	6,05
		230	2865	3,5	18,3	61	68	70	0,55	0,68	0,77	2,49	6,70
		380	2840	2,0	10,1	63	69	70	0,61	0,73	0,81	2,51	6,05
		400	2865	2,0	10,6	61	68	70	0,55	0,68	0,77	2,49	6,70
		415	2875	2,1	10,9	58	66	69	0,51	0,63	0,73	2,48	7,20
		500	2840	1,5	7,6	63	69	70	0,61	0,73	0,81	2,51	6,05
1,1	4000	220	2830	4,9	26,4	68	73	74	0,63	0,75	0,82	3,71	10,23
		230	2850	4,9	27,8	66	72	74	0,57	0,69	0,78	3,67	11,33
		380	2830	2,8	15,3	68	73	74	0,63	0,75	0,82	3,71	10,23
		400	2850	2,8	16,0	66	72	74	0,57	0,69	0,78	3,67	11,33
		415	2865	2,9	16,7	64	70	73	0,52	0,65	0,74	3,64	12,20
		500	2830	2,1	11,6	68	73	74	0,63	0,75	0,82	3,71	10,23
1,5	4000	220	2830	6,7	34,0	67	72	73	0,62	0,74	0,83	5,04	12,77
		230	2855	6,7	35,9	65	71	73	0,55	0,68	0,78	5,00	14,10
		380	2830	3,9	19,7	67	72	73	0,62	0,74	0,83	5,04	12,77
		400	2855	3,9	20,7	65	71	73	0,55	0,68	0,78	5,00	14,10
		415	2865	4,0	21,5	62	69	72	0,50	0,63	0,73	5,00	15,20
		500	2830	2,9	14,9	67	72	73	0,62	0,74	0,83	5,04	12,77
2,2	4000	220	2820	9,3	49,0	71	75	75	0,6	0,74	0,82	7,42	19,87
		230	2845	9,5	51,6	69	74	75	0,52	0,66	0,77	7,37	22
		380	2820	5,4	28,3	71	75	75	0,6	0,74	0,82	7,42	19,87
		400	2845	5,5	29,8	69	74	75	0,52	0,66	0,77	7,37	22
		415	2855	5,8	30,9	65	72	74	0,47	0,61	0,72	7,33	23,67
		500	2820	4,1	21,5	71	75	75	0,6	0,74	0,82	7,42	19,87
3	4000	220	2820	12,8	69,1	73	77	77	0,61	0,74	0,82	10,16	28,80
		230	2845	13,0	72,8	70	76	76	0,53	0,67	0,77	10,06	31,93
		380	2820	7,4	39,9	73	77	77	0,61	0,74	0,82	10,16	28,80
		400	2845	7,5	42,0	70	76	76	0,53	0,67	0,77	10,06	31,93
		415	2855	7,9	43,6	67	73	75	0,47	0,61	0,72	10,04	34,33
		500	2820	5,6	30,3	73	77	77	0,61	0,74	0,82	10,16	28,80

MOTOR PERFORMANCE DATA 60 HZ - 3-PHASE DESIGN

P _N [kW]	P _{MAX} [kW]	Thrust F [N]	U _N [V]	n _N [min ⁻¹]	I _N [A]	I _A [A]	η (Eff.) [%] at % load			cos φ (Pf.) at % load			T _N [Nm]	T _A [Nm]
							50	75	100	50	75	100		
0,37	0,59	4000	230	3455	2,7	14,1	65	71	73	0,56	0,68	0,77	1,6	4,0
			380	3455	1,6	8,5	65	71	73	0,56	0,68	0,77	1,6	4,0
			460	3455	1,4	7,0	65	71	73	0,56	0,68	0,77	1,6	4,0
0,55	0,83	4000	230	3445	3,7	19,6	60	65	66	0,59	0,71	0,79	2,3	5,6
			380	3445	2,3	11,9	60	65	66	0,59	0,71	0,79	2,3	5,6
			460	3445	1,9	9,8	60	65	66	0,59	0,71	0,79	2,3	5,6
0,75	1	4000	230	3410	4,5	22,0	61	67	70	0,64	0,75	0,82	2,8	6,4
			380	3410	2,7	13,3	61	67	70	0,64	0,75	0,82	2,8	6,4
			460	3410	2,3	11,0	61	67	70	0,64	0,75	0,82	2,8	6,4
1,1	1,4	4000	230	3415	6,0	32,2	66	72	74	0,64	0,75	0,82	3,9	10,2
			380	3415	3,6	19,5	66	72	74	0,64	0,75	0,82	3,9	10,2
			460	3415	3,0	16,1	66	72	74	0,64	0,75	0,82	3,9	10,2
1,5	1,8	4000	230	3430	7,8	40,8	67	73	75	0,60	0,72	0,80	5,0	11,5
			380	3430	4,7	24,7	67	73	75	0,60	0,72	0,80	5,0	11,5
			460	3430	3,9	20,4	67	73	75	0,60	0,72	0,80	5,0	11,5
2,2	2,5	4000	230	3425	10,8	57,4	69	74	76	0,57	0,70	0,78	7,0	18,0
			380	3425	6,5	34,7	69	74	76	0,57	0,70	0,78	7,0	18,0
			460	3425	5,4	28,7	69	74	76	0,57	0,70	0,78	7,0	18,0
3	3,4	4000	230	3425	14,5	79,4	71	76	77	0,57	0,70	0,79	9,5	23,8
			380	3425	8,8	48,1	71	76	77	0,57	0,70	0,79	9,5	23,8
			460	3425	7,2	39,7	71	76	77	0,57	0,70	0,79	9,5	23,8

4" SUPER STAINLESS MOTOR - 3-PHASE DESIGN

WINDING RESISTANCE DATA 50 HZ - 3-PHASE DESIGN

P_N [kW]	U_N [V]	Stator-Ref.	Main phase [Ohm]
0,37	220 - 230	326 775 ***	14,6 - 17,8
	380 - 400 - 415	326 710 ***	44,8 - 54,8
	500	326 787 ***	90,8 - 111,0
0,55	220 - 230	326 776 ***	11,3 - 13,8
	380 - 400 - 415	326 711 ***	34,2 - 41,8
	500	326 788 ***	57,3 - 70,0
0,75	220 - 230	326 777 ***	7,6 - 9,2
	380 - 400 - 415	326 712 ***	23,2 - 28,3
	500	326 789 ***	38,7 - 47,3
1,1	220 - 230	326 778 ***	4,5 - 5,4
	380 - 400 - 415	326 713 ***	13,8 - 16,8
	500	326 790 ***	23,1 - 28,3
1,5	220 - 230	326 779 ***	3,6 - 4,3
	380 - 400 - 415	326 714 ***	10,9 - 13,4
	500	326 791 ***	20,7 - 25,3
2,2	220 - 230	326 780 ***	2,5 - 3,0
	380 - 400 - 415	326 715 ***	7,1 - 8,6
	500	326 792 ***	11,9 - 14,5
3	220 - 230	326 781 ***	1,5 - 1,9
	380 - 400 - 415	326 716 ***	4,7 - 5,8
	500	326 793 ***	8,4 - 10,2

WINDING RESISTANCE DATA 60 HZ - 3-PHASE DESIGN

P_N [kW]	P_{MAX} [kW]	U_N [V]	Stator-Ref.	Main phase [Ohm]
0,37	0,59	230	326 828	9,4 - 11,5
		380	326 838	24,1 - 29,5
		460	326 710	
0,55	0,83	230	326 829	6,3 - 7,7
		380	326 839	16,5 - 20,2
		460	326 711	
0,75	1	230	326 830	5,7 - 6,9
		380	326 840	15,5 - 19,0
		460	326 712	23,2 - 28,3
1,1	1,4	230	326 831	3,4 - 4,1
		380	326 841	9,3 - 11,4
		460	326 713	13,8 - 16,8
1,5	1,8	230	326 832	2,7 - 3,3
		380	326 842	7,6 - 9,2
		460	326 714	10,9 - 13,4
2,2	2,5	230	326 833	1,8 - 2,2
		380	326 843	4,9 - 6,0
		460	326 715	7,1 - 8,6
3	3,4	230	326 834	1,2 - 1,4
		380	326 844	3,2 - 4,0
		460	326 716	4,7 - 5,8

MOTOR DESIGN AND DIMENSIONS

MOTOR DESIGN 304SS 4000N 0,37 - 3,0 KW

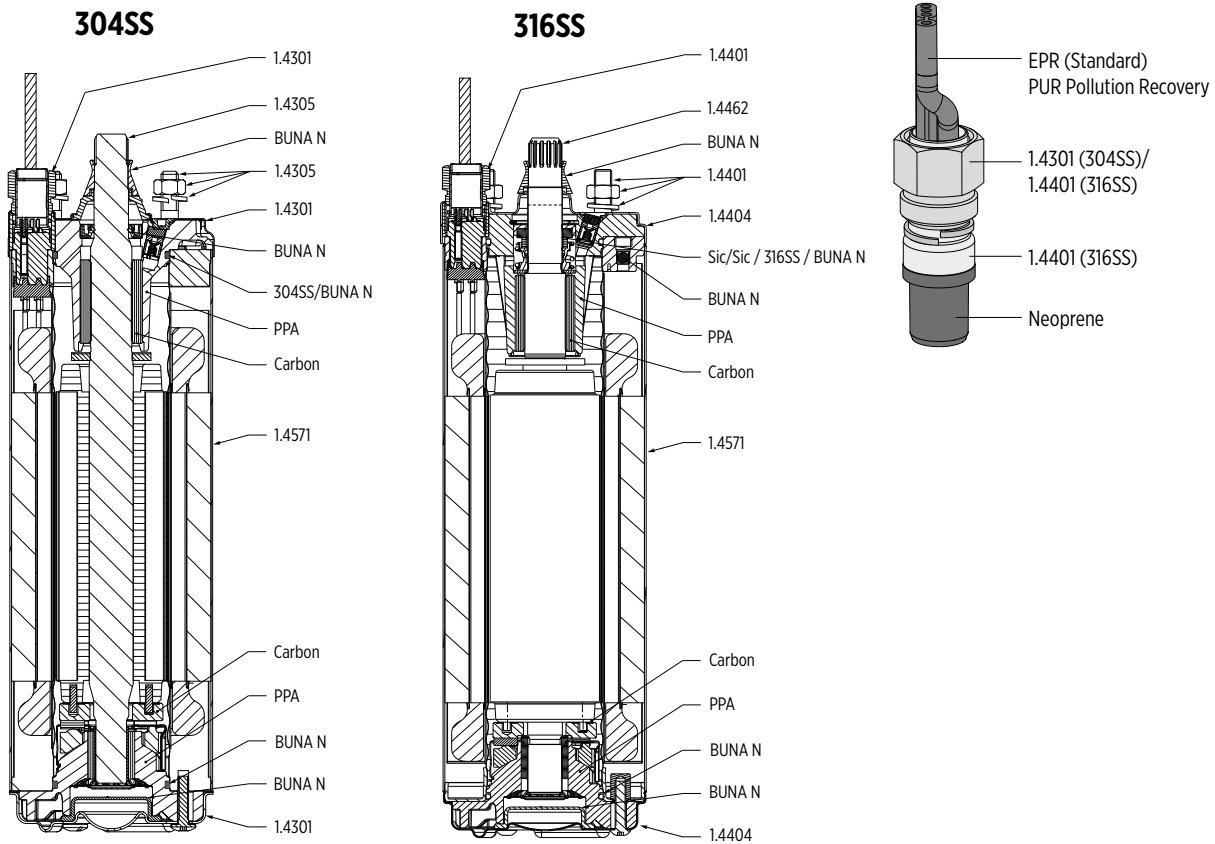

LENGTHS AND WEIGHTS - 3-PHASE DESIGN

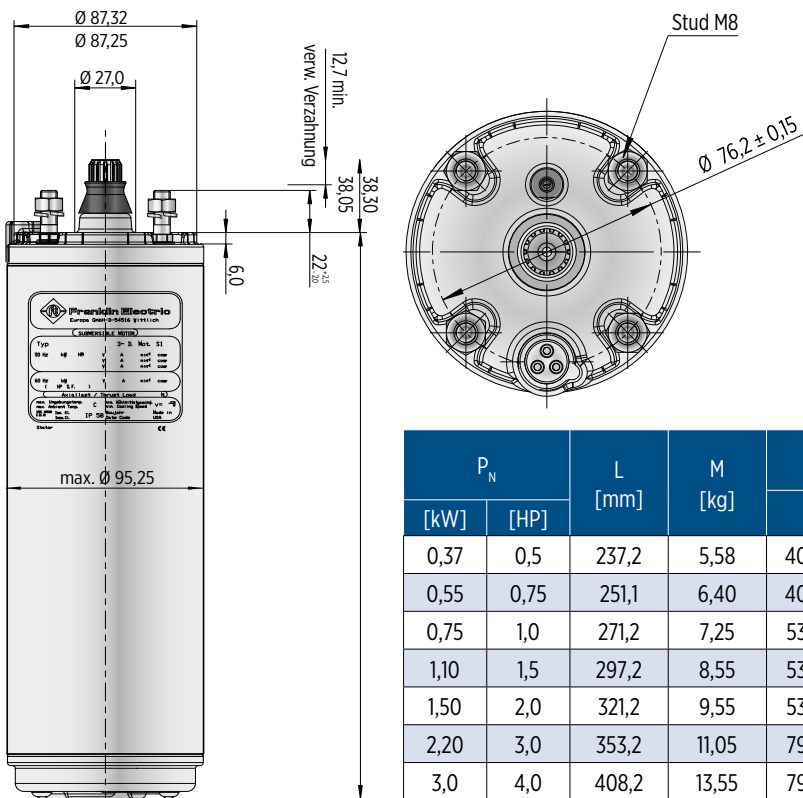

Tolerances according to NEMA MG 1-18.388

MOTOR LEADS 3-PHASE DESIGN

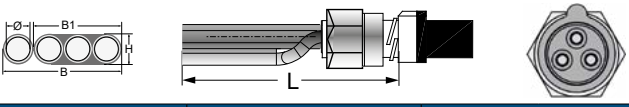
3 Phase motor leads			
0.25 - 3.0 kW			
Ø [mm ²]	B [mm]	B1 [mm]	H [mm]
3X1,5 + 1G1,5	16,8	10,7	5,0
			
L [m]	Model numbers 304SS	Model numbers 316SS	
1,5	310 113 401	310 113 501	
2,5	310 113 402	310 113 502	
5	310 113 405	310 113 505	
10	310 113 410	310 113 510	
15	310 113 415	310 113 515	
20	310 113 420	310 113 520	
30	310 113 430	310 113 530	
40	310 113 440	310 113 540	
50	310 113 450	310 113 550	

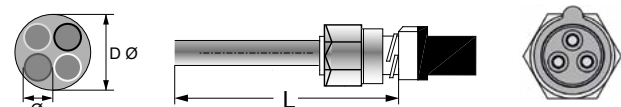
3-phase Pollution Recovery motor leads	
0.25 - 3.0 kW	
Ø [mm ²]	D Ø [mm]
1,5	9,8
	
L [m]	Model numbers 316SS
1,5	310 313 501
2,5	310 313 502
10	310 313 510
20	310 313 520
30	310 313 530
40	310 313 540
50	310 313 550

Cables are designed for submerged operation. For air operation, please consult Franklin Electric.

CONNECTION - 3-PHASE DESIGN

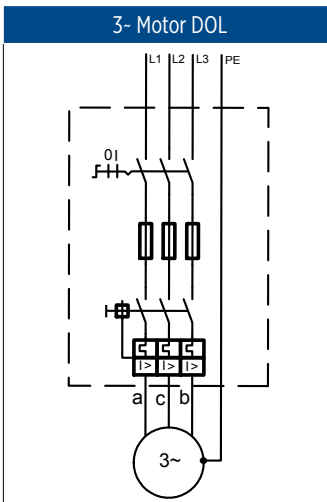

a = black | b = brown | c = grey | PE = yellow/green

MOTOR PART DESCRIPTION

MOTOR DESIGN 0.37 - 3.0 KW

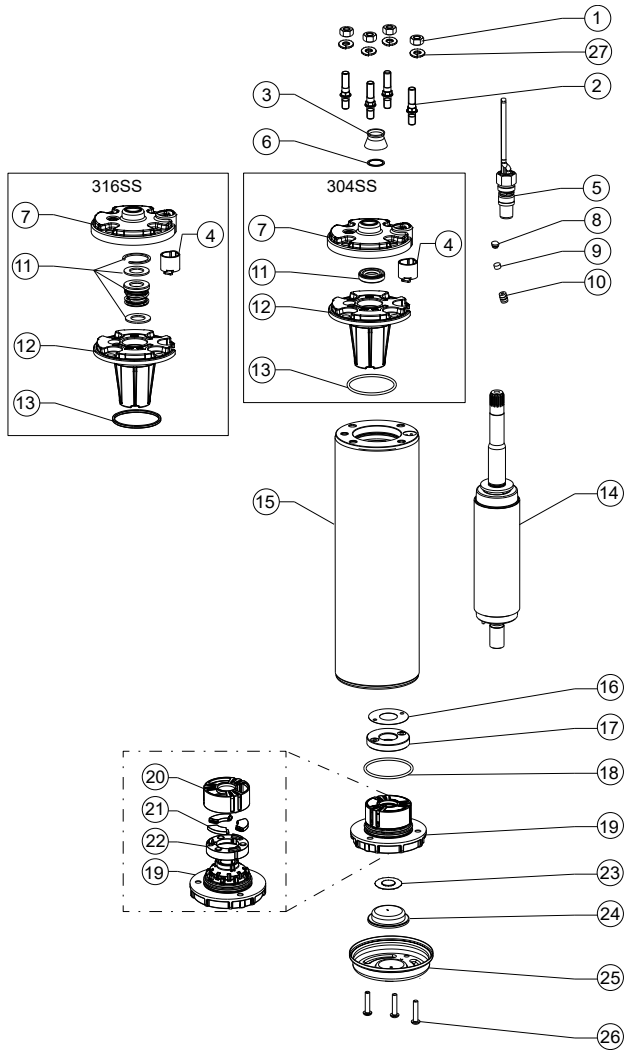

Pos.	Part Description	Qty.	Part No.
1	Nut	4	Kit C
2	Stud	4	Kit C
3	Protector, Spline	1	Kit B
4	Connector boss	1	151 820 103
5	Motor Lead	1	Page 38
6	Washer	1	Kit B
7	Top Endbell, Cover 304SS	1	150 262 151
	Top Endbell, Cover 316SS	1	150 262 251
8	Filter plug	1	Kit
9	Filter	1	Kit
10	Valve	1	Kit
11	Shaft Seal	1	Kit B
12	Top Endbell	1	Kit
13	O-Ring	1	Kit B
14	Rotor	1	Page 40/41
15	Stator	1	Page 40/41
16	Level washer	1	Kit A2
17	Thrust disk assy	1	Kit A2
18	O-Ring	1	Kit B / Kit A2
19	Bottom Endbell	1	Kit A2
20	Bearing cage	1	Kit A2
21	Segments	3	Kit A2
22	Gasket	1	Kit A2
23	Diaphragm washer	1	151 314 101 / Kit A2
24	Diaphragm	1	Kit B / Kit A2
25	Bottom Endbell Cover 304SS	1	156 414 201 / Kit A2
	Bottom Endbell Cover 316SS	1	156 414 301 / Kit A2
26	Screw, Cover	3	Kit C
27	Lock washer	4	Kit C

MOTOR SPARE PARTS

SPARE PARTS KITS

P_N [kW]	0.25 - 3.0 kW		
Kit A1	Top Endbell 304SS	incl. pos. 4, 7, 8, 9, 10, 11, 12, 13	308 462 902
	Top Endbell 316SS		308 462 952
Kit A2	Bottom Endbell 304SS incl. Thrust Bearing Kit 4000N	incl. pos. 16 - 22	308 464 911
	Bottom Endbell 316SS incl. Thrust Bearing Kit 4000N		308 464 912
Kit B	Seal Kit Standard 304SS	incl. pos. 3, 6, 8, 9, 11, 13, 18, 23, 24	308 650 201
	Seal Kit Standard 316SS*		308 650 251
	Seal Kit Pollution Recovery 304SS		308 650 202
	Seal Kit Pollution Recovery 316SS		308 650 252
Kit C	Fastener Kit 304SS	incl. pos. 1, 2, 26, 27	308 656 202
	Fastener Kit 316SS		308 656 252

SPARE PARTS 3~ DESIGN 50 HZ - STATOR AND ROTOR 0.37 - 3.0 KW

P_N [kW]	U_N [V]	Model no. stator 304SS / 316SS	Model no. rotor 304SS	Model no. rotor 316SS
0,37	220, 230	305 491 851	178 164 901K	178 164 921K
	380 -415	305 491 861		
	500	305 491 871		
0,55	220, 230	305 491 852	178 164 902 K	178 164 922K
	380 -415	305 491 862		
	500	305 491 872		
0,75	220, 230	305 491 853	178 164 903 K	178 164 923K
	380 -415	305 491 863		
	500	305 491 873		
1,1	220, 230	305 491 854	178 164 905 K	178 164 925K
	380 -415	305 491 864		
	500	305 491 874		
1,5	220, 230	305 491 855	178 164 907K	178 164 927K
	380 -415	305 491 865		
	500	305 491 875		
2,2	220, 230	305 491 856	178 164 908K	178 164 928K
	380 -415	305 491 866		
	500	305 491 876		
3,0	220, 230	305 491 857	178 164 910K	178 164 920K
	380 -415	305 491 867		
	500	305 491 877		

SPARE PARTS 3~ DESIGN 60 HZ - STATOR AND ROTOR 0.37 - 3.0 KW

P_N [kW]	$P_{Nmax.}$ [kW]	U_N [V]	Model no. stator 304SS / 316SS	Model no. rotor 304SS	Model no. rotor 316SS
0,37	0,59	230	305 491 901	178 164 902K	178 164 922K
		380	305 491 911		
		460	305 491 921E		
0,55	0,83	230	305 491 902	178 164 903K	178 164 923K
		380	305 491 912		
		460	305 491 922E		
0,75	1	230	305 491 903	178 164 903K	178 164 923K
		380	305 491 913		
		460	305 491 923E		
1,10	1,4	230	305 491 904	178 164 905K	178 164 925K
		380	305 491 914		
		460	305 491 924E		
1,50	1,8	230	305 491 905	178 164 907K	178 164 927K
		380	305 491 915		
		460	305 491 925E		
2,20	2,5	230	305 491 906	178 164 908K	178 164 928K
		380	305 491 916		
		460	305 491 926E		
3,00	3,4	230	305 491 907	178 164 910K	178 164 930K
		380	305 491 917		
		460	305 491 927E		