

50Hz



water solutions

blue series bluePRO series

DG blue
DR blue

DG bluePRO
DR bluePRO
GR bluePRO
AP bluePRO

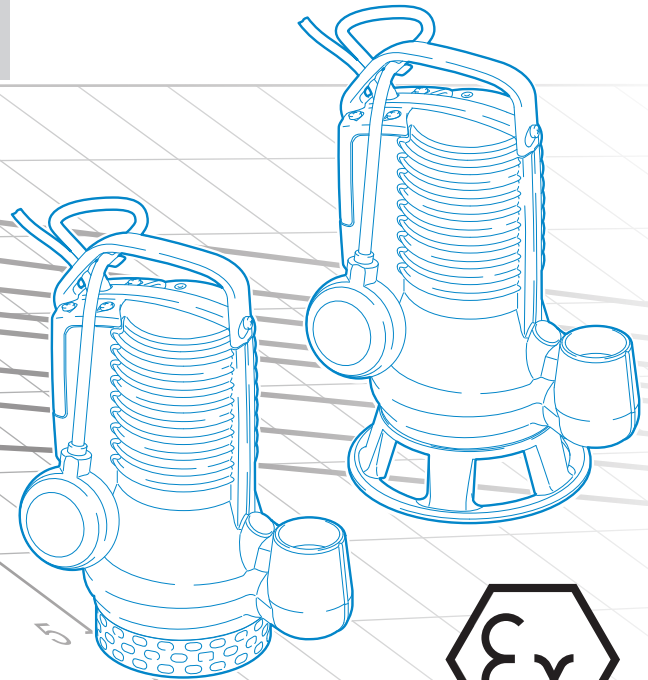



water solutions

blue series

bluePRO series

DG blue

DR blue

DG bluePRO

DR bluePRO

GR bluePRO

AP bluePRO



D A T A B O O K L E T

blue Series

General characteristics

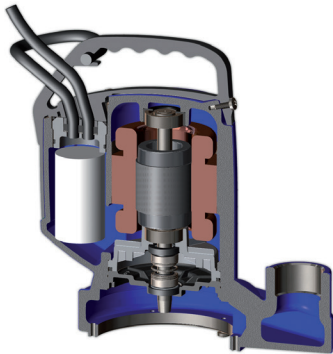

- Ergonomic technopolymer lifting and carrying handle. Clip floatswitch adjustment.
- Innovative cable gland system with twin O-rings to ensure maximum tightness.
- Dry motor with thermal protections. Internal startup capacitor.
- One silicon carbide mechanical seal (SiC) and one alumina graphite mechanical seal (AL), V-ring in direct contact with the liquid.
- Oil sump which guarantees longer mechanical seal lifetime, and is easily accessible thanks to a patented system to simplify maintenance procedures.
- Full free passage allowing the expulsion of solids and preventing fouling of the impeller (DG).
- Intake strainer in impact-resistant polypropylene (DR).



Models available on request with **ATEX** certification, suitable for installation in the presence of potentially explosive gases, powders and liquids.

Ex II 3G
Ex nA IIC T3 Gc
Ex h IIC T3 Gc

Ex II 3G
Ex nA nC IIC T3 Gc
Ex h IIC T3 Gc

Hydraulic families



DG (Draga)

Set-back vortex impeller
 Suitable with slightly soiled biological wastewaters and sewage. Suitable for domestic and residential use

page 7

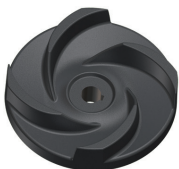

DR (Dreno)

Multi-channel open impeller
 Can be used with clear or slightly soiled wastewaters containing small solids, strained water, rainwater, seepage and water pumped from underground. Suitable for specifically domestic use

page 10

Key to product code

DRblue 50/2/G32V A0BM5

① ② ③ (A) (B) (C) ④ ⑤ ⑥ ⑦ ⑧ ⑨

- | | |
|--------------------------------|----------------------------------|
| ① Family | ⑤ Hydraulic model |
| ② Series | ⑥ Version number |
| ③ Power (HPx100) / motor poles | ⑦ Motor size |
| ④ Delivery rate | ⑧ Motor phases |
| (A) TYPE (GAS thread/Flanged) | M = Single-phase |
| (B) DIAMETER (mm) | T = Three-phase |
| (C) POSITION | ⑨ Power supply voltage frequency |
| V = vertical | 5 = 50Hz |
| H = horizontal | 6 = 60Hz |

Operating ranges

DG blue

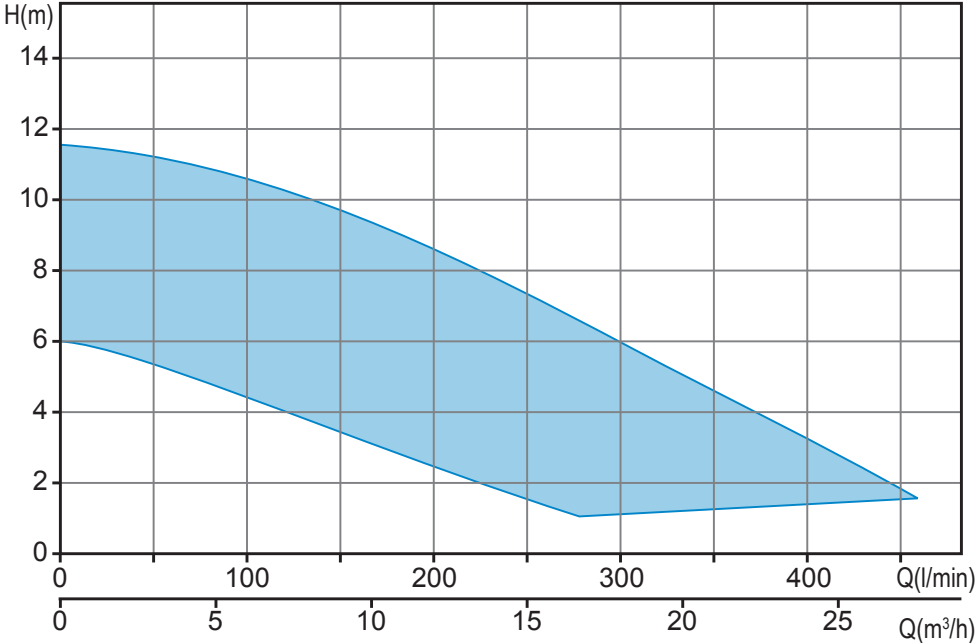

DR blue

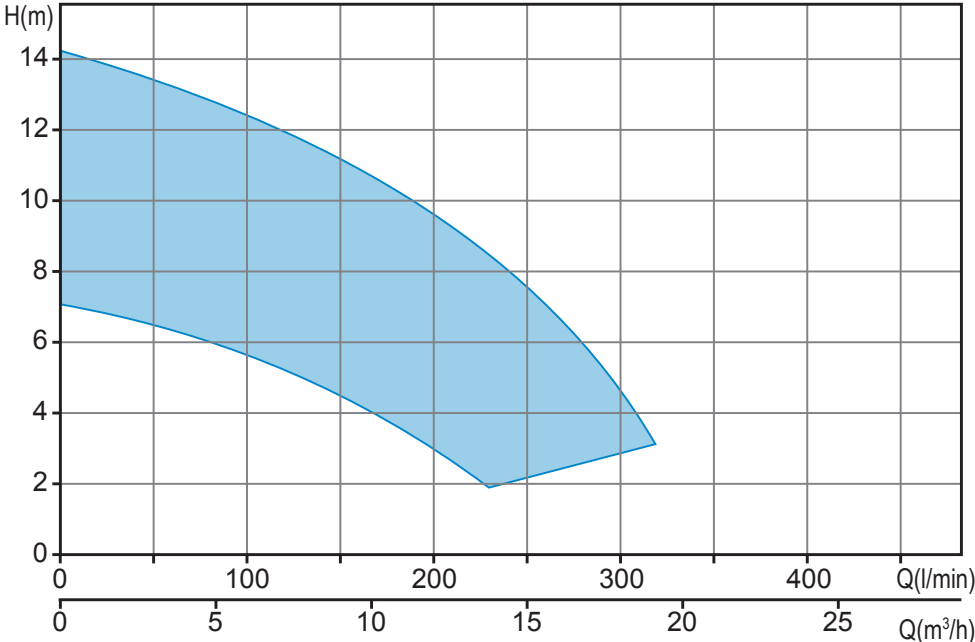

Versions available

• Electrical variants

Single-phase models

TC	Thermal protection, capacitor
TCG	Thermal protection, capacitor, floatswitch

• Cooling system

N	No cooling and/or seal flushing system
----------	--

• Mechanical seals

SICAL	One silicon carbide mechanical seal (SiC) and one alumina graphite mechanical seal (AL), V-ring
--------------	---

Installations

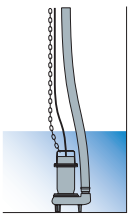

Free installation

The electric pump, standing on its feet or base, is connected to the delivery flexible pipe using a joint fixed to the discharge.
This installation allows to move easily the electrical pump

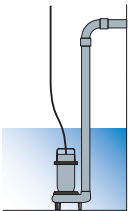

Fixed installation

The electric pump, standing on its feet or base, is connected to the delivery pipe, which is screwed to the discharge if threaded, or fixed to a bend if the port is flanged.
The pump-hose connection may be threaded or flanged, depending on the pump fitting.

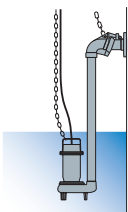

Installation with external coupler

Available for electric pumps with threaded discharge. The pump unit is supported by a special device fitted to the delivery pipe.
This device can be installed at any time without having to empty the tank.
It simplifies any maintenance work on the pump, which can be lifted out and resubmerged with great ease. It is recommended in particular for installations of small size, and does not require the pump to be resting on the bottom of the tank.

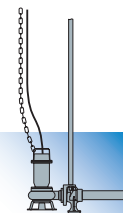
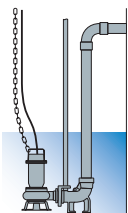

Installation with base coupling foot

For submerged installation, available for electric pumps with flanged or threaded horizontal discharge.
The coupling device is fixed to the bottom of the tank and the pump is lowered in with the aid of two guide pipes fitted earlier, until the connection to the foot is completed.
The delivery pipe is fixed to the coupling device discharge.
This device makes routine checks, any maintenance work or replacement of the pump extremely easy, with no need to empty the tank.
A specific kit also allowing pumps with vertical discharge to be installed with the base coupling foot is available.

Pumps with vortex impeller

Operating ranges

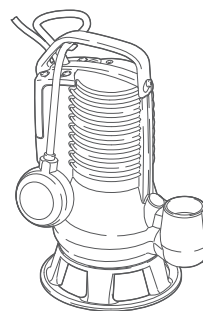
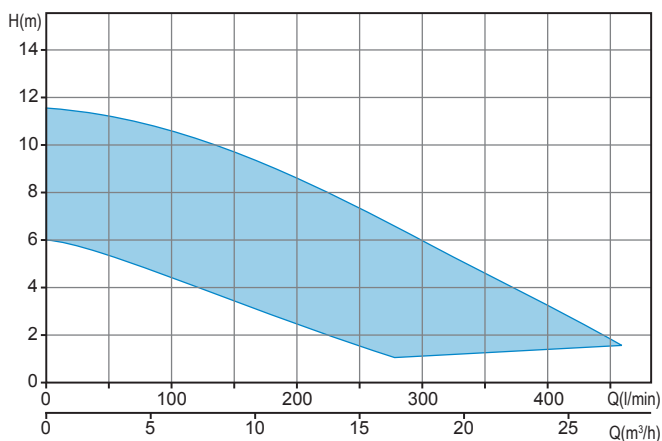

Range characteristics

Motor power	0.3 ÷ 0.74 kW
Poles	2
Insulation class	F
Degree of protection	IP68
Discharge	GAS 1½" vertical
Free passage	max 40 mm
Max flow rate	7.7 l/s (462 l/min)
Max head	11.6 m

Motor

Dry motor with thermal protections.

Cable

H07RN-F 5 m cable length with schuko plug. Optional 10 m cable length with schuko plug.

Mechanical seals

One silicon carbide mechanical seal (SiC) and one alumina graphite mechanical seal (AL), V-ring

Applications

Used with soiled biological wastewaters and sewage. Suitable and reliable for domestic use and residential applications.

Versions

Electrical variants	TC, TCG (single-phase models)
Cooling system	N
Mechanical seals	SICAL

Operating specifications

Max operating temperature	40 °C
PH of treated fluid	6 ÷ 14
Viscosity of treated fluid	1 mm²/s
Maximum immersion depth	20 m
Density of treated fluid	1 Kg/dm³
Acoustic pressure max	<70dB
Max starts per hour	30

Construction materials

Case	Cast iron EN-GJL 250
Hydraulic parts	Cast iron EN-GJL 250
Impeller	Technopolymer
Nuts and bolts	Stainless steel - Class A2-70
Standard gasket	Rubber - NBR
Shaft	Stainless steel - AISI 420
Paint type	Ecological bicomponent epoxy (~ 80 µm)

Installations

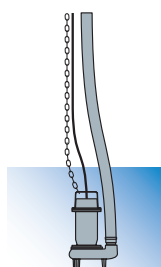

FREE

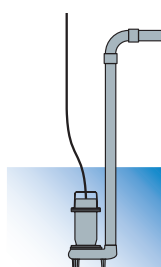

FIXED

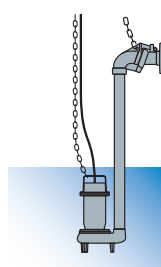

with EXTERNAL COUPLER

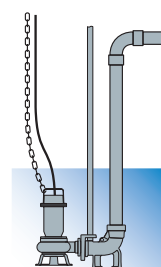

with BASE COUPLING FOOT

DG blue 2/G40V

Performances

	l/s	0	1	2	3	4	5	6	7
	l/min	0	60	120	180	240	300	360	420
	m³/h	0	3.6	7.2	10.8	14.4	18.0	21.6	25.2
① DG blue 40/2/G40V A1BM5		6.0	5.2	4.0	2.8	1.7			
② DG blue 50/2/G40V A1BM5		7.6	6.7	5.5	4.2	2.9	1.6		
③ DG blue 75/2/G40V A1BM5		10.1	9.5	8.5	7.2	5.7	4.2	2.6	
④ DG blue 100/2/G40V A1BM5		11.6	11.2	10.2	9.1	7.6	6.0	4.3	2.7

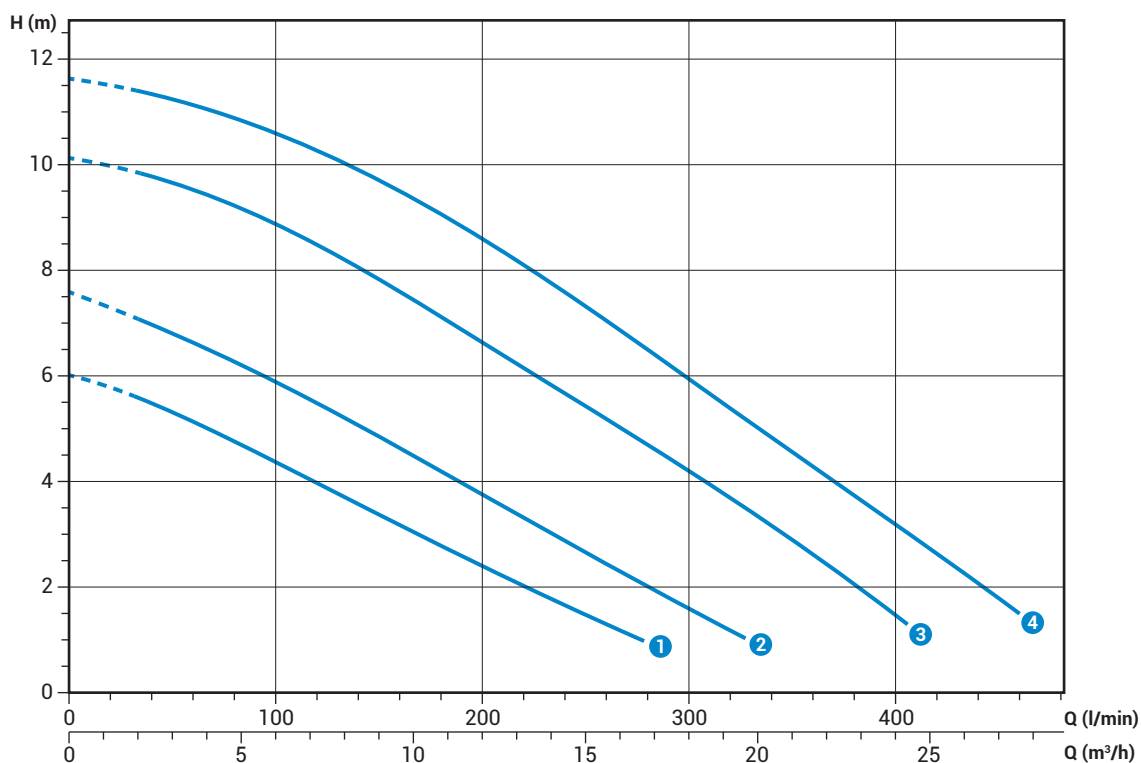

Characteristic curves according to UNI/EN ISO 9906

Technical data

	V	Phases	P1 (kW)	P2 (kW)	A	Rpm	Start	Cable	Ø	Free passage
① DG blue 40/2/G40V A1BM5	230	1	-	0.3	2.3	2900	G 1½"	40 mm	G 1½"	40 mm
② DG blue 50/2/G40V A1BM5	230	1	-	0.37	2.8	2900	G 1½"	40 mm	G 1½"	40 mm
③ DG blue 75/2/G40V A1BM5	230	1	-	0.55	4.1	2900	G 1½"	40 mm	G 1½"	40 mm
④ DG blue 100/2/G40V A1BM5	230	1	-	0.74	5.6	2900	G 1½"	40 mm	G 1½"	40 mm

Overall dimensions and weights

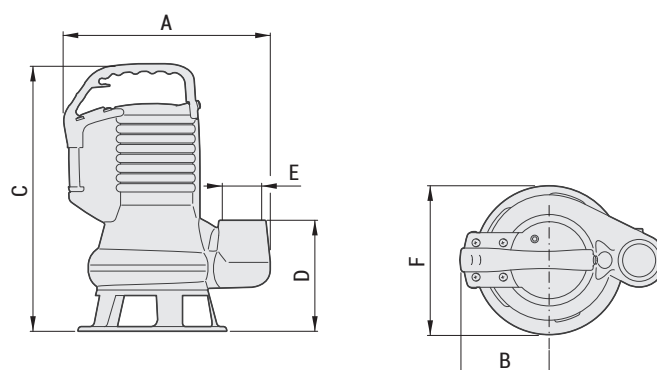

	A	B	C	D	E	F	kg
DG blue 40/2/G40V A1BM5	265	115	335	140	G 1 1/2"	190	12.5
DG blue 50/2/G40V A1BM5	265	115	335	140	G 1 1/2"	190	13
DG blue 75/2/G40V A1BM5	265	115	365	140	G 1 1/2"	190	15
DG blue 100/2/G40V A1BM5	265	115	365	140	G 1 1/2"	190	15.5

Dimensions in mm

Packaging dimension



	X	Y	Z
DG blue 40/2/G40V A1BM5	240	200	400
DG blue 50/2/G40V A1BM5	240	200	400
DG blue 75/2/G40V A1BM5	240	200	400
DG blue 100/2/G40V A1BM5	240	200	400

Dimensions in mm

DR blue

Pumps with multi-channel open impeller

Operating ranges

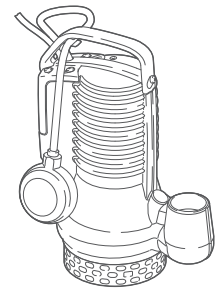
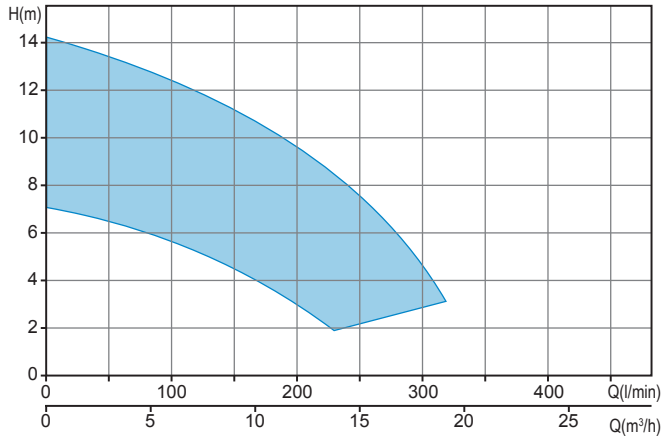

Range characteristics

Motor power	0.3 ÷ 0.74 kW
Poles	2
Insulation class	F
Degree of protection	IP68
Discharge	GAS 1 ¼" vertical
Free passage	max 7 mm
Max flow rate	5.3 l/s (318 l/min)
Max head	14.2 m

Motor

Dry motor with thermal protections.

Cable

H07RN-F 5 m cable length with schuko plug. Optional 10 m cable length with schuko plug.

Mechanical seals

One silicon carbide mechanical seal (SiC) and one lip seal (AL).

Applications

The ideal solution for use with clear or slightly soiled wastewaters containing small solids, strained water, rainwater, seepage and water pumped from underground. Suitable and reliable for domestic use, including heavy-duty applications.

Installations

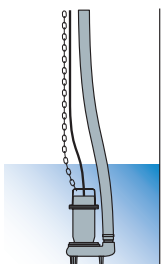

FREE

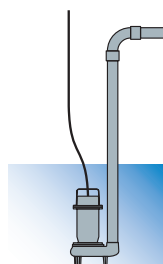

FIXED

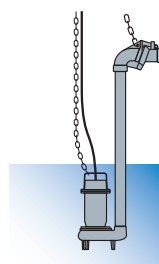

with EXTERNAL COUPLER

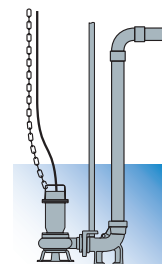

with BASE COUPLING FOOT

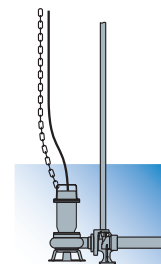

Versions

Electrical variants	TC, TCG (single-phase models)
Cooling system	N
Mechanical seals	SICAL

Operating specifications

Max operating temperature	40 °C
PH of treated fluid	6 ÷ 14
Viscosity of treated fluid	1 mm²/s
Maximum immersion depth	20 m
Density of treated fluid	1 Kg/dm³
Acoustic pressure max	<70dB
Max starts per hour	30

Construction materials

Case	Cast iron EN-GJL 250
Hydraulic parts	Cast iron EN-GJL 250
Impeller	Technopolymer
Nuts and bolts	Stainless steel - Class A2-70
Standard gasket	Rubber - NBR
Shaft	Stainless steel - AISI 420
Paint type	Ecological bicomponent epoxy (~ 80 µm)

DR blue 2/G40V**Performances**

	l/s	0	1	2	3	4	5
	l/min	0	60	120	180	240	300
	m ³ /h	0	3.6	7.2	10.8	14.4	18.0
① DR blue 40/2/G32V A1BM5		7.0	6.3	5.1	3.6		
② DR blue 50/2/G32V A1BM5		9.5	8.4	7.0	5.1	2.7	
③ DR blue 75/2/G32V A1BM5		12.0	10.8	9.3	7.3	5.0	
④ DR blue 100/2/G32V A1BM5		14.2	13.3	11.9	10.3	8.0	4.5

Characteristic curves according to UNI EN ISO 9906

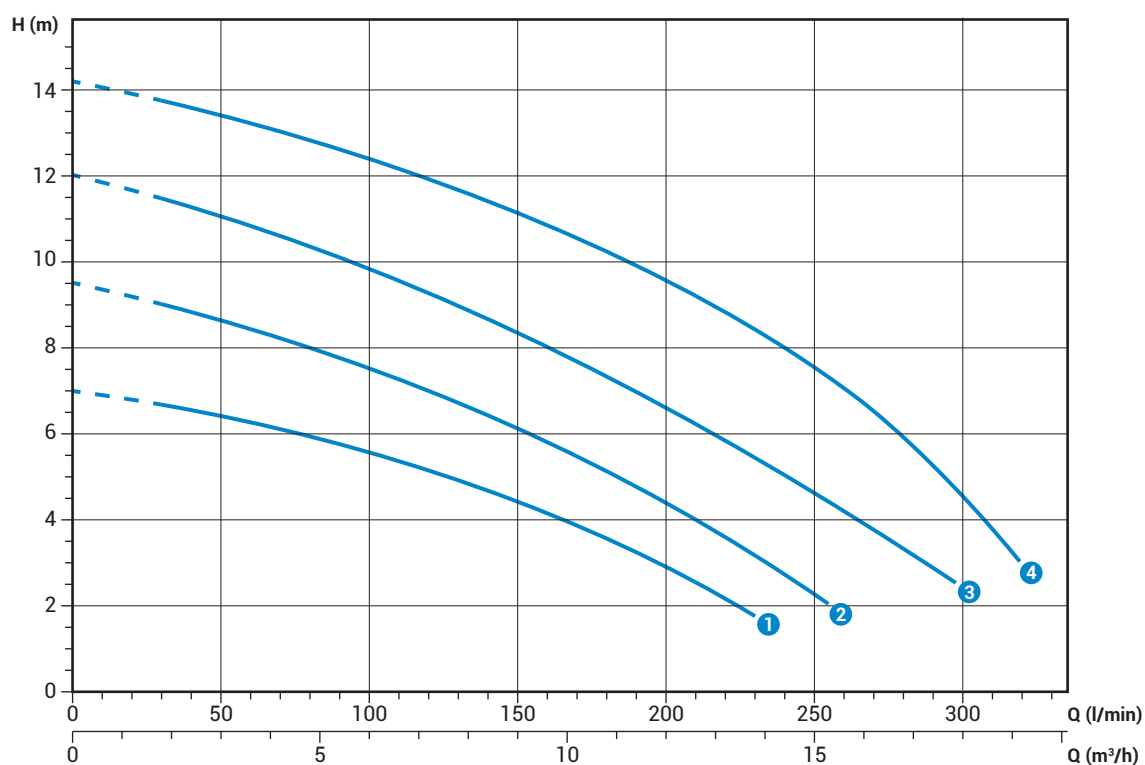
**Technical data**

	V	Phases	P1 (kW)	P2 (kW)	A	Rpm	Start	Cable	Ø	Free passage
① DR blue 40/2/G32V A1BM5	230	1	-	0.3	2.3	2900	Dir	3G1	G 1¼"	15 mm
② DR blue 50/2/G32V A1BM5	230	1	-	0.37	2.8	2900	Dir	3G1	G 1¼"	15 mm
③ DR blue 75/2/G32V A1BM5	230	1	-	0.55	4.1	2900	Dir	3G1	G 1¼"	15 mm
④ DR blue 100/2/G32V A1BM5	23	1	-	0.74	5.6	2900	DiR	3G1	G 1¼"	15 mm

DR blue

Overall dimensions and weights

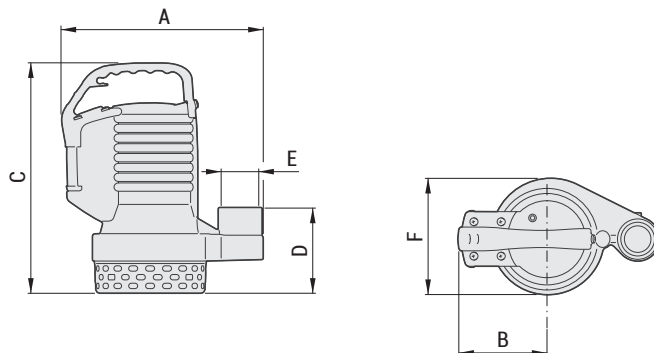

	A	B	C	D	E	F	kg
DR blue 40/2/G40V A1BM5	255	115	295	110	G 1¼"	150	11.5
DR blue 50/2/G40V A1BM5	255	115	295	110	G 1¼"	150	12
DR blue 75/2/G40V A1BM5	255	115	325	110	G 1¼"	150	13.5
DR blue 100/2/G40V A1BM5	255	115	325	110	G 1¼"	150	15.5

Dimensions in mm

Packaging dimension



	X	Y	Z
DR blue 40/2/G40V A1BM5	240	200	350
DR blue 50/2/G40V A1BM5	240	200	350
DR blue 75/2/G40V A1BM5	240	200	350
DR blue 100/2/G40V A1BM5	240	200	350

Dimensions in mm

bluePRO Series

General characteristics

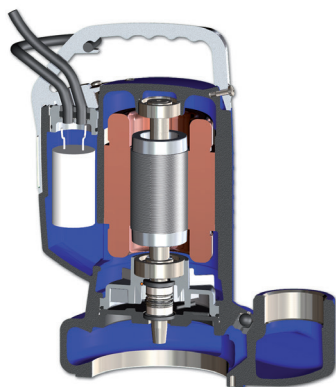

- Ergonomic aluminium lifting and carrying handle, coated for excellent mechanical strength and corrosion resistance. Clip floatswitch adjustment.
- Innovative cable gland system with twin O-rings to ensure maximum tightness.
- Dry motor with thermal protections. Single-phase models with internal capacitor. Three-phase models with motor protection relay (option).
- Two silicon carbide mechanical seals (2SiC), and V-ring in direct contact with the liquid.
- Oil sump which guarantees longer mechanical seal lifetime, and is easily accessible thanks to a patented system to simplify maintenance procedures.
- Breather which allows the air to be vented and ensure reliable pump priming even after long periods out of use.



Models available on request with **ATEX** certification, suitable for installation in the presence of potentially explosive gases, powders and liquids.



Ex nA IIC T3 Gc
Ex h IIC T3 Gc



Ex nA nC IIC T3 Gc
Ex h IIC T3 Gc

Hydraulic families



DG (Draga)

page 16

Set-back vortex impeller
Full free passage allowing the expulsion of solids and preventing fouling of the impeller.
Suitable for heavy-duty applications with soiled biological wastewaters, sewage, rainwater and seepage.
This electric pump is intended for both domestic and professional use.

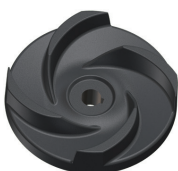

DR (Dreno)

page 20

Multi-channel open impeller
Stainless steel intake strainer and diffuser plate (models 50, 75 and 100).
Polypropylene intake strainer with cast iron diffuser plate and foot (models 150 and 200).
Suitable for use with clear or slightly soiled wastewaters containing small solids, strained water, rainwater, seepage and water pumped from underground, where high pumping rates are required.
This electric pump is intended for both domestic and professional use.

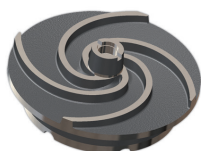

GR (Grinder)

page 24

Impeller with grinder system
Grinder system comprising a revolving cutter and a plate with holes with sharpened edges that fine-chops filaments, preventing fouling of the impeller.
Recommended for unstrained civil wastewaters, including those containing filaments or fibres.
This electric pump is intended for both domestic and professional use.

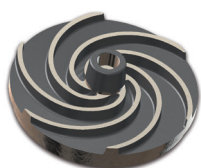

AP (Alta prevalenza)

page 27

High head impeller
Used for clear wastewater, rainwater and seepage containing small amounts of sand.
Its high manometric head makes this series suitable for the creation of water features and decorative fountains.
This electric pump is intended for both domestic and professional use.

Operating ranges

DG bluePRO

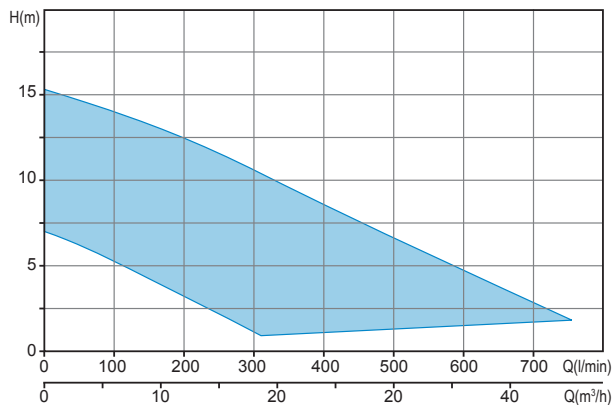

DR bluePRO

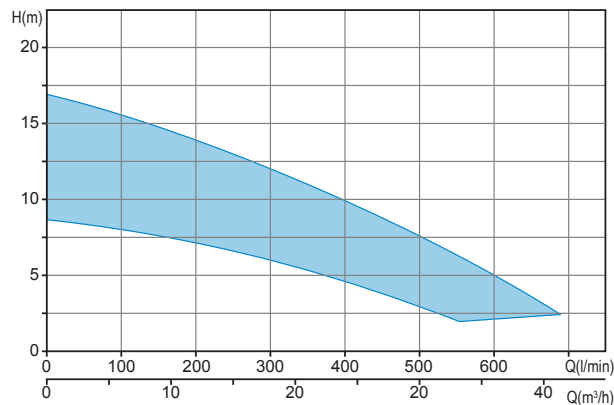

GR bluePRO

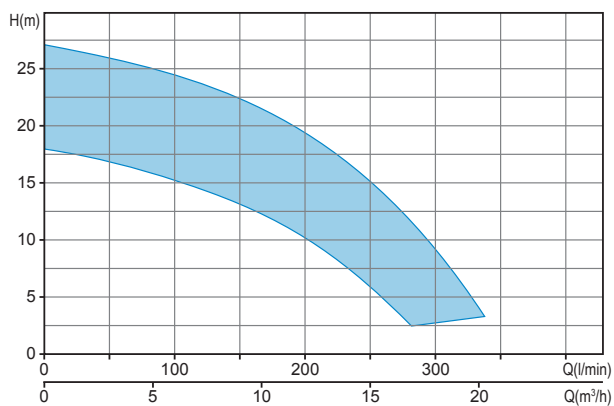

AP bluePRO

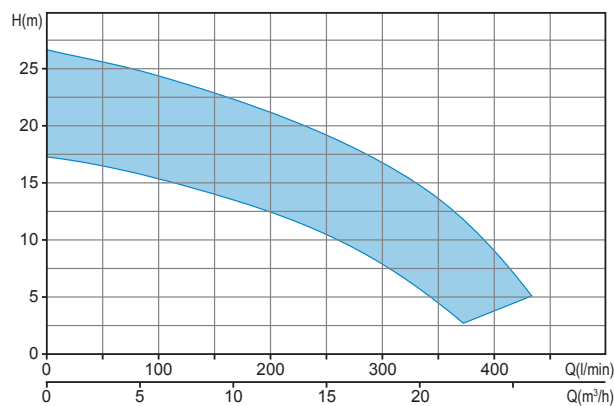

Key to product code

DR bluePRO 50/2/G32V A0BM5

- | | | | | | | | | |
|----------|----------|--------------------------------|---|-------------------|------------------|--------------|---|--|
| ① | ② | ③ | ④ | ⑤ | ⑥ | ⑦ | ⑧ | ⑨ |
| ① Family | ② Series | ③ Power (HPx100) / motor poles | ④ Delivery rate
(A) TYPE (GAS thread/Flanged)
(B) DIAMETER (mm)
(C) POSITION
V = vertical
H = horizontal | ⑤ Hydraulic model | ⑥ Version number | ⑦ Motor size | ⑧ Motor phases
M = Single-phase
T = Three-phase | ⑨ Power supply voltage frequency
5 = 50Hz
6 = 60Hz |

Versions available

• Electrical variants

Single-phase models

TC	Thermal protection, capacitor
TCG	Thermal protection, capacitor, float switch
TCDT	Thermal protection, capacitor, startup capacitor, overload protection
TCDGT	Thermal protection, capacitor, startup capacitor, overload protection, float switch

Three-phase models

NAE	No electric accessories installed
TR	Thermal protection, relay for motor protection
TRG	Thermal protection, relay for motor protection, float switch

• Cooling system

N	No cooling and/or seal flushing system
----------	--

• Set of mechanical seals

2SiC	Two silicon carbide mechanical seals (2SiC), V-ring
-------------	---

Installations

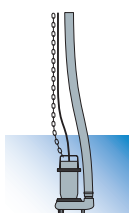

Free installation

The electric pump, standing on its feet or base, is connected to the delivery flexible pipe using a joint fixed to the discharge. This installation allows to move easily the electrical pump

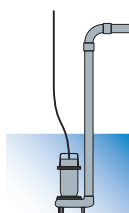

Fixed installation

The electric pump, standing on its feet or base, is connected to the delivery pipe, which is screwed to the discharge if threaded, or fixed to a bend if the port is flanged. The pump-hose connection may be threaded or flanged, depending on the pump fitting.

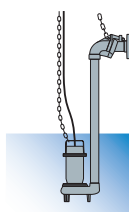

Installation with external coupler

Available for electric pumps with threaded discharge. The pump unit is supported by a special device fitted to the delivery pipe. This device can be installed at any time without having to empty the tank. It simplifies any maintenance work on the pump, which can be lifted out and resubmerged with great ease. It is recommended in particular for installations of small size, and does not require the pump to be resting on the bottom of the tank.

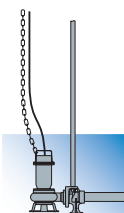
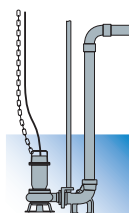

Installation with base coupling foot

For submerged installation, available for electric pumps with flanged or threaded horizontal discharge. The coupling device is fixed to the bottom of the tank and the pump is lowered in with the aid of two guide pipes fitted earlier, until the connection to the foot is completed. The delivery pipe is fixed to the coupling device discharge. This device makes routine checks, any maintenance work or replacement of the pump extremely easy, with no need to empty the tank. A specific kit also allowing pumps with vertical discharge to be installed with the base coupling foot is available.

DG bluePRO

Pumps with vortex impeller

Operating ranges

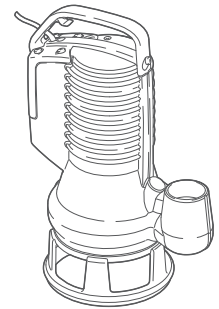
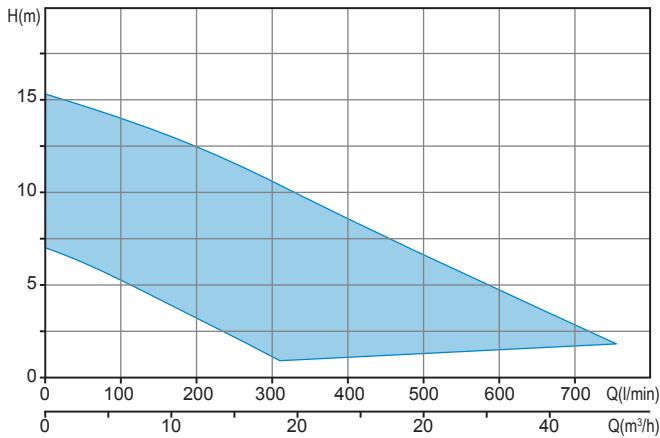

Range characteristics

Motor power	0.37 ÷ 1.5 kW
Poles	2
Insulation class	F
Degree of protection	IP68
Discharge	GAS 1½" - 2" vertical
Free passage	max 50 mm
Max flow rate	12.6 l/s (756 l/min)
Max head	15.3 m

Motor

Dry motor with thermal protections.

Cable

H07RN-F - 5 m cable length. Optional 10 m cable length.

Mechanical seals

Two silicon carbide mechanical seals (2SiC), V-ring

Applications

Suitable for heavy-duty applications with soiled biological wastewaters, sewage, rainwater and seepage. This electric pump is intended for both domestic and professional use.

Installations

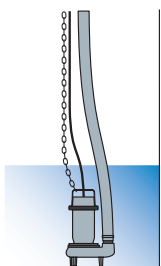

FREE

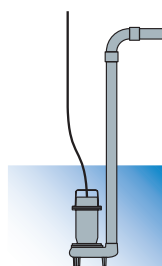

FIXED

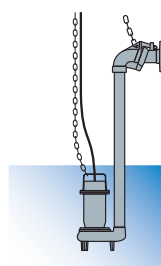

with EXTERNAL COUPLER

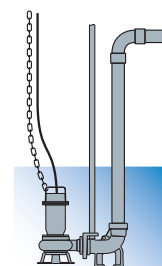

with BASE COUPLING FOOT

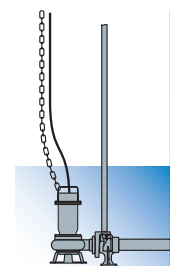

Versions

Electrical variants	TC, TCG (single-phase models) NAE, TRG (three-phase models)
Cooling system	N
Mechanical seals	2SiC

Operating specifications

Max operating temperature	40 °C
PH of treated fluid	6 ÷ 14
Viscosity of treated fluid	1 mm²/s
Maximum immersion depth	20 m
Density of treated fluid	1 Kg/dm³
Acoustic pressure max	<70dB
Max starts per hour	30

Construction materials

Case	Cast iron EN-GJL 250
Hydraulic parts	Cast iron EN-GJL 250
Impeller	Cast iron EN-GJL 250
Nuts and bolts	Stainless steel - Class A2-70
Standard gasket	Rubber - NBR
Shaft	Stainless steel - AISI 420
Paint type	Ecological bicomponent epoxy (~ 80 µm)

DG bluePRO 2/G40V

Performances

	l/s	0	1	2	3	4	5	6	7
	l/min	0	60	120	180	240	300	360	420
	m³/h	0	3.6	7.2	10.8	14.4	18.0	21.6	25.2
① DG bluePRO 50/2/G40V A1BM(T)5		7.0	6.0	4.9	3.6	2.4	1.1		
② DG bluePRO 75/2/G40V A1BM(T)5		10.2	9.1	8.0	6.8	5.5	4.1	2.6	
③ DG bluePRO 100/2/G40V A1BM(T)5		11.4	10.7	9.8	8.7	7.4	5.9	4.4	2.7

Characteristic curves according to UNI/EN ISO 9906

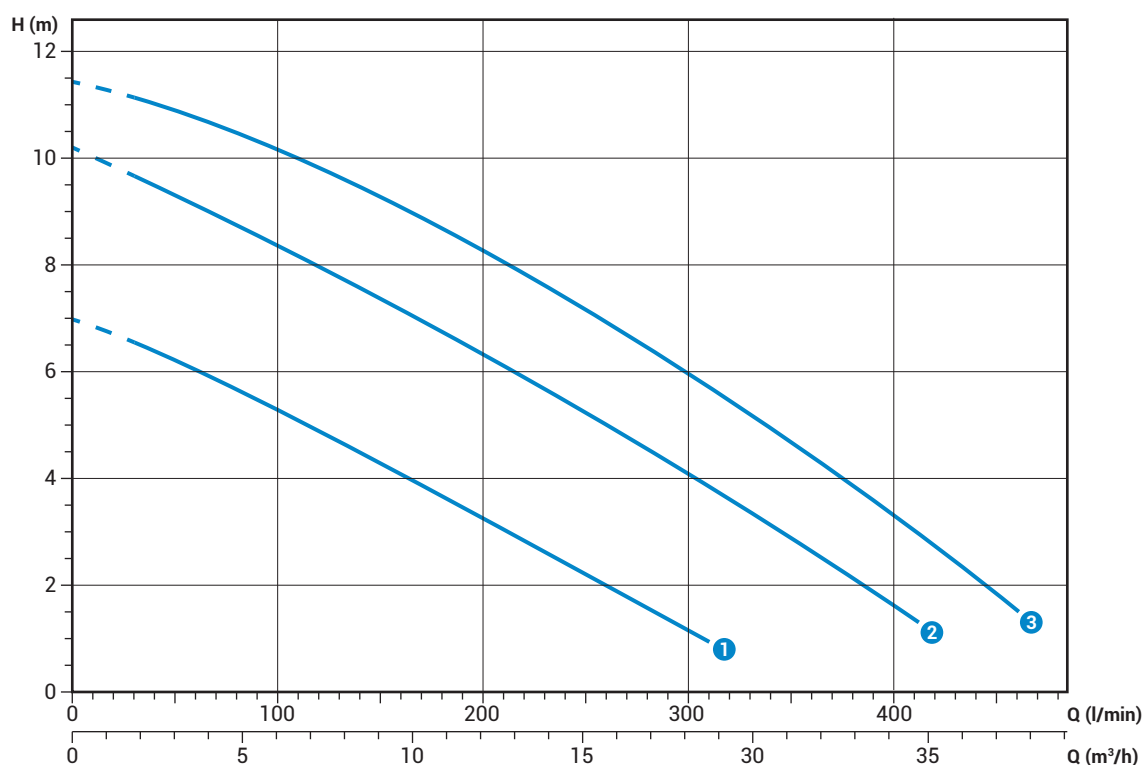

Technical data

	V	Phases	P1 (kW)	P2 (kW)	A	Rpm	Start	Cable	Ø	Free passage
① DG bluePRO 50/2/G40V A1BM5	230	1	-	0.37	2.8	2900	Dir	3G1	G 1½"	40 mm
② DG bluePRO 75/2/G40V A1BM5	230	1	-	0.55	4.1	2900	Dir	3G1	G 1½"	40 mm
③ DG bluePRO 100/2/G40V A1BM5	230	1	-	0.74	5.6	2900	Dir	3G1	G 1½"	40 mm

	V	Phases	P1 (kW)	P2 (kW)	A	Rpm	Start	Cable	Ø	Free passage
① DG bluePRO 50/2/G40V A1BT5	400	3	-	0.37	1.15	2900	Dir	4G1	G 1½"	40 mm
② DG bluePRO 75/2/G40V A1BT5	400	3	-	0.55	1.6	2900	Dir	4G1	G 1½"	40 mm
③ DG bluePRO 100/2/G40V A1BT5	400	3	-	0.74	2.15	2900	Dir	4G1	G 1½"	40 mm

DG bluePRO 2/G50V

Performances

	l/s	0	1	2	3	4	5	6	7	8	9	10	11	12
	l/min	0	60	120	180	240	300	360	420	480	540	600	660	720
	m³/h	0	3.6	7.2	10.8	14.4	18.0	21.6	25.2	28.8	32.4	36.0	39.6	43.2
① DG bluePRO 150/2/G50V A1CM(T)5		12.3	11.5	10.7	9.7	8.8	7.6	6.5	5.3	4.4	3.3	2.4		
② DG bluePRO 200/2/G50V A1CM(T)5		15.3	14.6	13.7	12.7	11.7	10.6	9.4	8.2	7.1	5.9	4.7	3.5	2.5

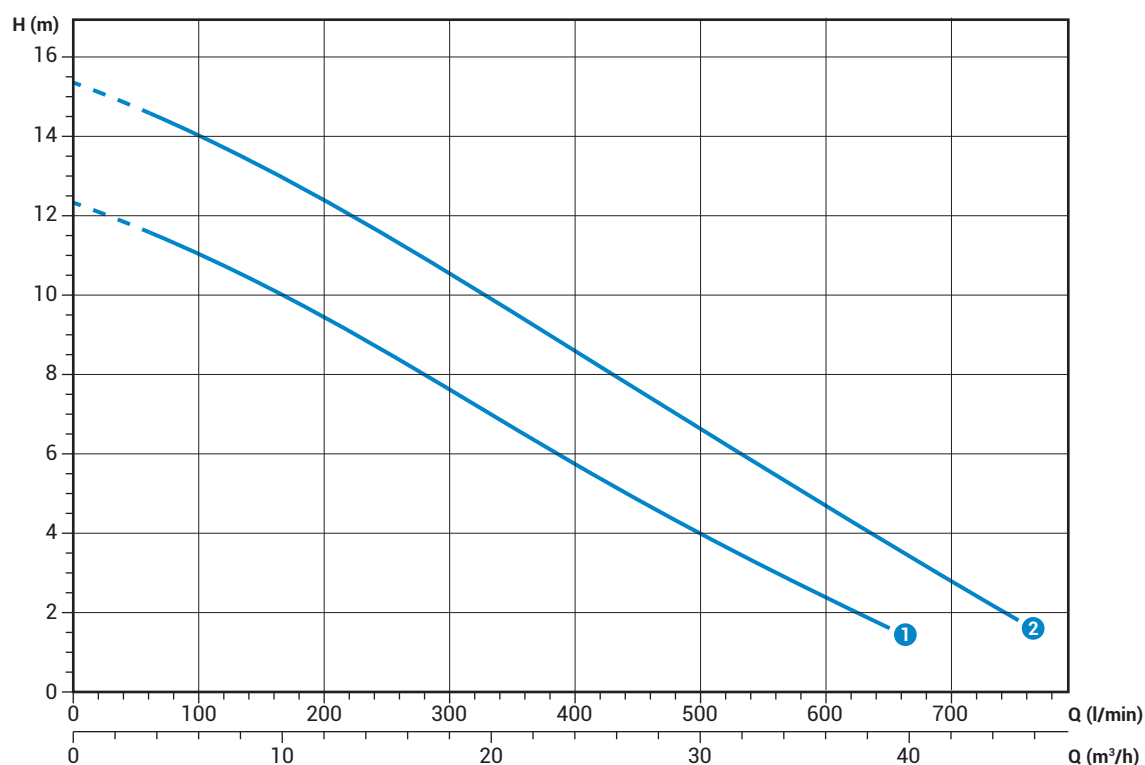

Characteristic curves according to UNI EN ISO 9906

Technical data

	V	Phases	P1 (kw)	P2 (kw)	A	Rpm	Start	Cable	Ø	Free passage
① DG bluePRO 150/2/G50V A1CM5	230	1	-	1.1	7.5	2900	Dir	3G1	G 2"	50 mm
② DG bluePRO 200/2/G50V A1CM5	230	1	-	1.5	10	2900	Dir	3G1	G 2"	50 mm

	V	Phases	P1 (kw)	P2 (kw)	A	Rpm	Start	Cable	Ø	Free passage
① DG bluePRO 150/2/G50V A1CT5	400	3	-	1.1	3.2	2900	Dir	4G1	G 2"	50 mm
② DG bluePRO 200/2/G50V A1CT5	400	3	-	1.5	4.3	2900	Dir	4G1	G 2"	50 mm

DG bluePRO

Overall dimensions and weights

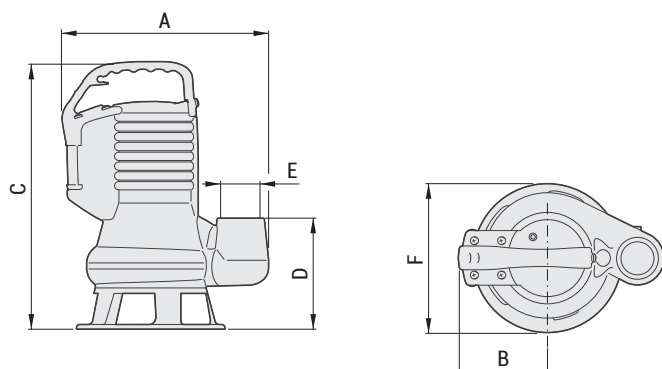

	A	B	C	D	E	F	kg
DG bluePRO 50/2/G40V A1BM(T)5	265	115	335	140	G 1½"	190	13
DG bluePRO 75/2/G40V A1BM(T)5	265	115	365	140	G 1½"	190	15
DG bluePRO 100/2/G40V A1BM(T)5	265	115	365	140	G 1½"	190	15.5

Dimensions in mm

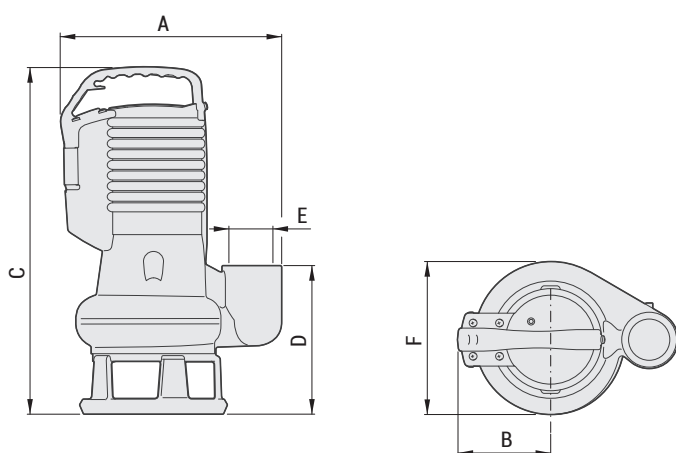

	A	B	C	D	E	F	kg
DG bluePRO 150/2/G50V A1CM(T)5	295	125	465	195	G 2"	200	23
DG bluePRO 200/2/G50V A1CM(T)5	295	125	465	195	G 2"	200	24

Dimensions in mm

Packaging dimension



	X	Y	Z
DG bluePRO 50/2/G40V A1BM(T)5	240	200	400
DG bluePRO 75/2/G40V A1BM(T)5	240	200	400
DG bluePRO 100/2/G40V A1BM(T)5	240	200	400
DG bluePRO 150/2/G50V A1CM(T)5	300	250	480
DG bluePRO 200/2/G50V A1CM(T)5	300	250	480

Dimensions in mm

DR bluePRO

Pumps with multi-channel open impeller

Operating ranges

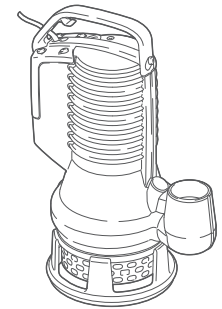
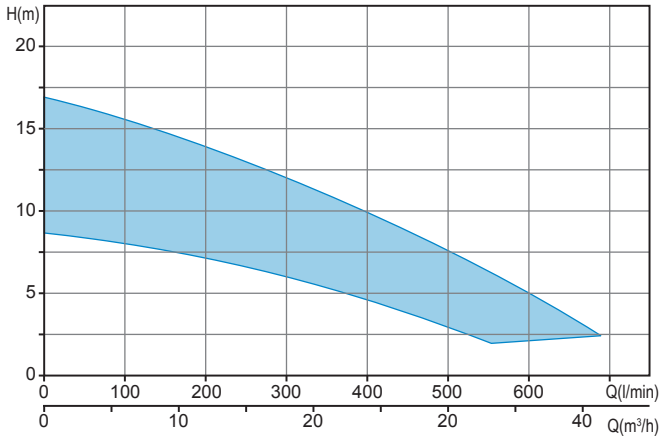

Range characteristics

Motor power	0.37 ÷ 1.5 kW
Poles	2
Insulation class	F
Degree of protection	IP68
Discharge	GAS 1 ¼" - 2" vertical
Free passage	max 15 mm
Max flow rate	11.5 l/s (690 l/min)
Max head	17.0 m

Motor

Dry motor with thermal protections.

Cable

H07RN-F - 5 m cable length. Optional 10 m cable length.

Mechanical seals

Two silicon carbide mechanical seals (2SiC), V-ring

Applications

Suitable for use with clear or slightly soiled wastewaters containing small solids, strained water, rainwater, seepage and water pumped from underground, where high pumping rates are required. This electric pump is intended for both domestic and professional use.

Versions

Electrical variants	TC, TCG (single-phase models) NAE, TRG (three-phase models)
Cooling system	N
Mechanical seals	2SiC

Operating specifications

Max operating temperature	40 °C
PH of treated fluid	6 ÷ 14
Viscosity of treated fluid	1 mm²/s
Maximum immersion depth	20 m
Density of treated fluid	1 Kg/dm³
Acoustic pressure max	<70dB
Max starts per hour	30

Construction materials

Case	Cast iron EN-GJL 250
Hydraulic parts	Cast iron EN-GJL 250
Impeller	Cast iron EN-GJL 250
Nuts and bolts	Stainless steel - Class A2-70
Standard gasket	Rubber - NBR
Shaft	Stainless steel - AISI 420
Paint type	Ecological bicomponent epoxy (~ 80 µm)

Installations

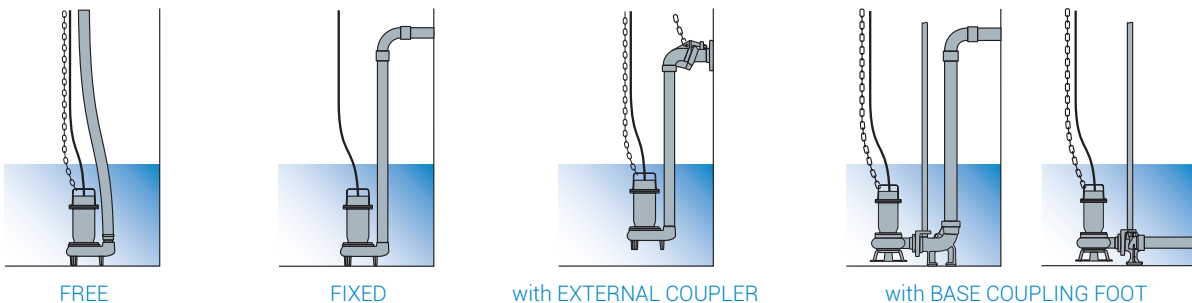

DR bluePRO 2/G32V**Performances**

	l/s	0	1	2	3	4	5
	l/min	0	60	120	180	240	300
	m ³ /h	0	3.6	7.2	10.8	14.4	18.0
① DR bluePRO 50/2/G32V A1BM(T)5		8.7	7.9	6.8	5.3	3.4	
② DR bluePRO 75/2/G32V A1BM(T)5		12.3	11.3	10.0	8.2	5.3	
③ DR bluePRO 100/2/G32V A1BM(T)5		14.6	13.5	12.1	10.1	7.4	3.1

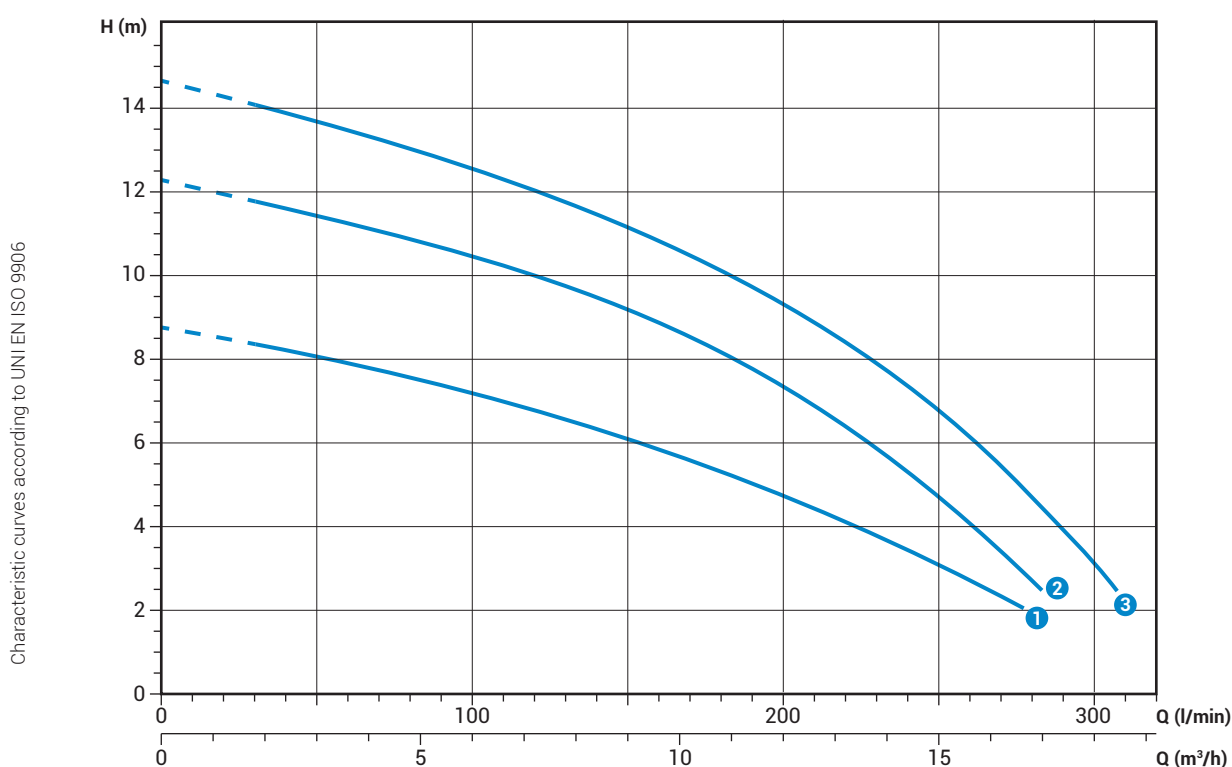
**Technical data**

	V	Phases	P1 (kW)	P2 (kW)	A	Rpm	Start	Cable	Ø	Free passage
① DR bluePRO 50/2/G32V A1BM5	230	1	-	0.37	2.8	2900	Dir	3G1	G 1¼"	15 mm
② DR bluePRO 75/2/G32V A1BM5	230	1	-	0.55	4.1	2900	Dir	3G1	G 1¼"	15 mm
③ DR bluePRO 100/2/G32V A1BM5	230	1	-	0.74	5.6	2900	Dir	3G1	G 1¼"	15 mm

	V	Phases	P1 (kW)	P2 (kW)	A	Rpm	Start	Cable	Ø	Free passage
① DR bluePRO 50/2/G32V A1BT5	400	3	-	0.37	1.15	2900	Dir	4G1	G 1¼"	15 mm
② DR bluePRO 75/2/G32V A1BT5	400	3	-	0.55	1.6	2900	Dir	4G1	G 1¼"	15 mm
③ DR bluePRO 100/2/G32V A1BT5	400	3	-	0.74	2.15	2900	Dir	4G1	G 1¼"	15 mm

DR bluePRO 2/G50V

Performances

	l/s	0	1	2	3	4	5	6	7	8	9	10	11
	l/min	0	60	120	180	240	300	360	420	480	540	600	660
	m³/h	0	3.6	7.2	10.8	14.4	18.0	21.6	25.2	28.8	32.4	36.0	39.6
① DR bluePRO 150/2/G50V A1CM(T)5		14.4	13.5	12.6	11.8	10.9	9.9	8.9	7.8	6.5	5.0	3.1	
② DR bluePRO 200/2/G50V A1CM(T)5		17.0	16.2	15.3	14.3	13.3	12.1	10.9	9.5	8.1	6.6	5.1	3.3

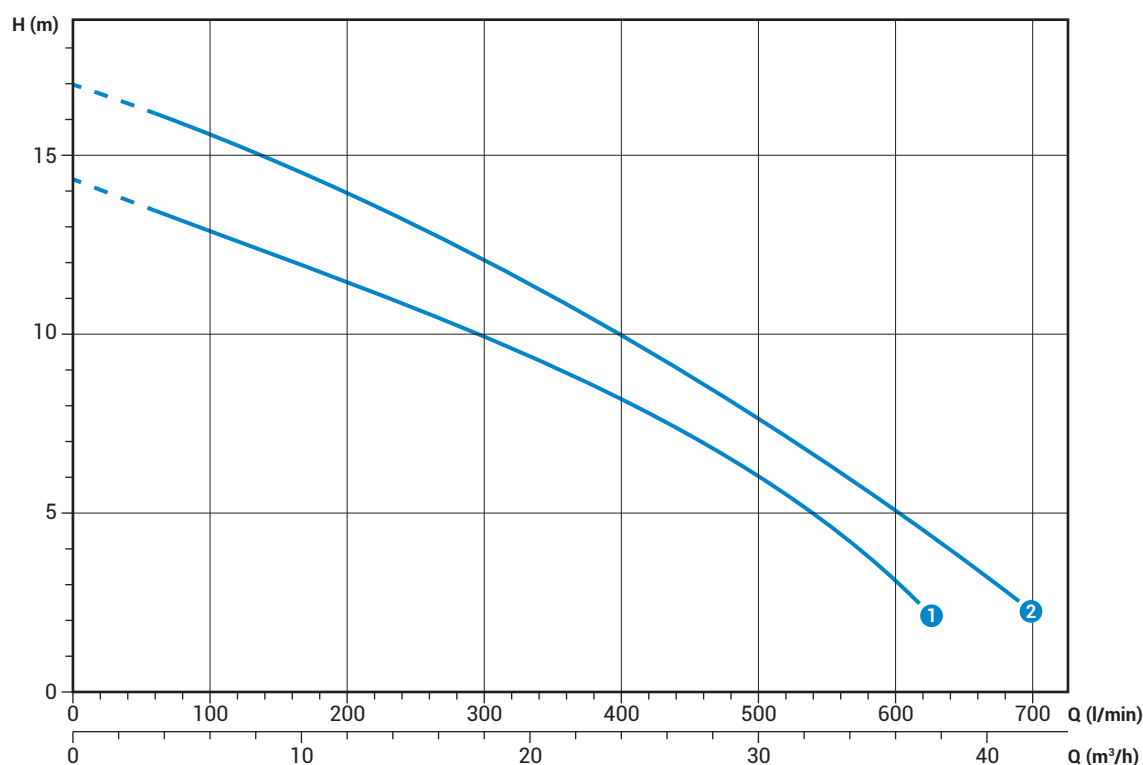

Characteristic curves according to UNI EN ISO 9906

Technical data

	V	Phases	P1 (kW)	P2 (kW)	A	Rpm	Start	Cable	Ø	Free passage
① DR bluePRO 150/2/G50V A1CM5	230	1	-	1.1	7.5	2900	Dir	3G1	G 2"	10x30 mm
② DR bluePRO 200/2/G50V A1CM5	230	1	-	1.5	10	2900	Dir	3G1	G 2"	10x30 mm

	V	Phases	P1 (kW)	P2 (kW)	A	Rpm	Start	Cable	Ø	Free passage
① DR bluePRO 150/2/G50V A1CT5	400	3	-	1.1	3.2	2900	Dir	4G1	G 2"	10x30 mm
② DR bluePRO 200/2/G50V A1CT5	400	3	-	1.5	4.3	2900	Dir	4G1	G 2"	10x30 mm

DR bluePRO

Overall dimensions and weights

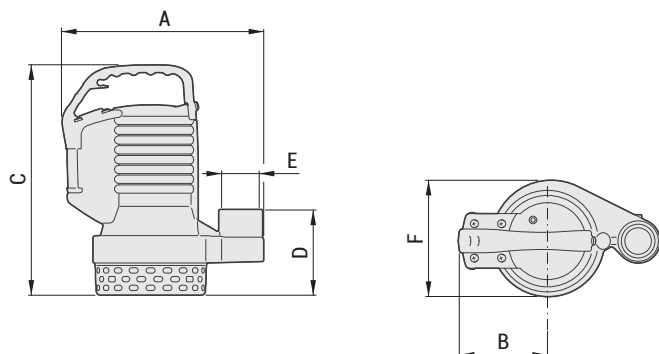

	A	B	C	D	E	F	kg
DR bluePRO 50/2/G32V A1BM(T)5	255	115	290	110	G 1¼"	150	12
DR bluePRO 75/2/G32V A1BM(T)5	255	115	320	110	G 1¼"	150	13.5
DR bluePRO 100/2/G32V A1BM(T)5	255	115	320	110	G 1¼"	150	14

Dimensions in mm

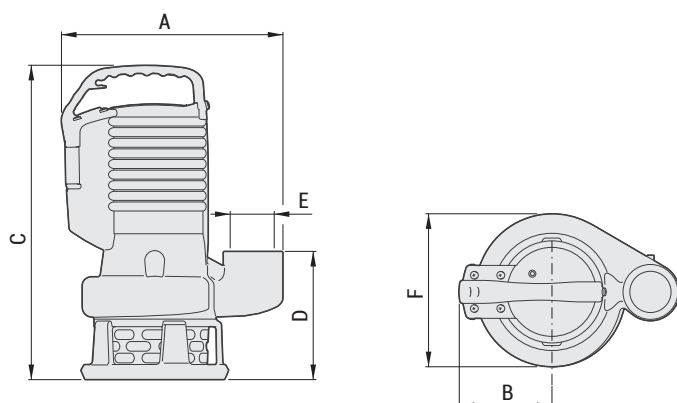

	A	B	C	D	E	F	kg
DR bluePRO 150/2/G50V A1CM(T)5	295	125	420	170	G 2"	200	23
DR bluePRO 200/2/G50V A1CM(T)5	295	125	420	170	G 2"	200	24

Dimensions in mm

Packaging dimension



	X	Y	Z
DR bluePRO 50/2/G32V A1BM(T)5	240	200	350
DR bluePRO 75/2/G32V A1BM(T)5	240	200	350
DR bluePRO 100/2/G32V A1BM(T)5	240	200	350
DR bluePRO 150/2/G50V A1CM(T)5	300	250	480
DR bluePRO 200/2/G50V A1CM(T)5	300	250	480

Dimensions in mm

GR bluePRO

Grinder pumps

Operating ranges

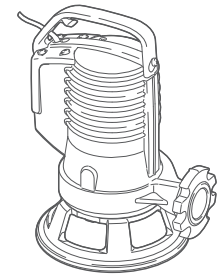
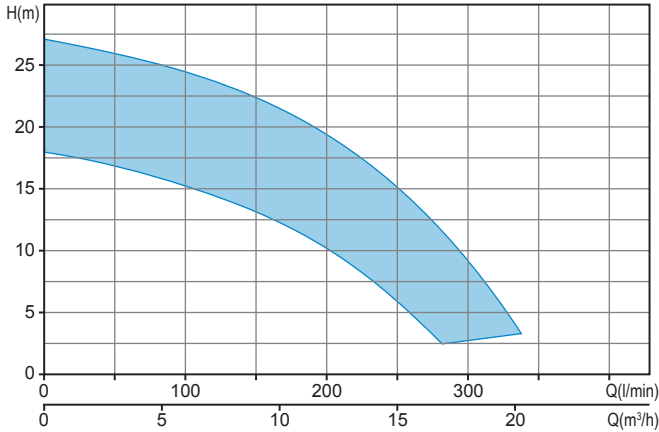

Range characteristics

Motor power	0.74 ÷ 1.5 kW
Poles	2
Insulation class	F
Degree of protection	IP68
Discharge	GAS 1 1/2" - DN32 horizontal
Free passage	-
Max flow rate	5.6 l/s (336 l/min)
Max head	27 m

Motor

Dry motor with thermal protections.

Cable

H07RN-F - 5 m cable length. Optional 10 m cable length.

Mechanical seals

Two silicon carbide mechanical seals (2SiC), V-ring

Applications

Recommended for unstrained civil wastewaters, including those containing filaments or fibres. This electric pump is intended for both domestic and professional use.

Versions

Electrical variants	TCDT, TCDGT (single-phase models) TR, TRG (three-phase models)
Cooling system	N
Mechanical seals	2SiC

Operating specifications

Max operating temperature	40 °C
PH of treated fluid	6 ÷ 14
Viscosity of treated fluid	1 mm²/s
Maximum immersion depth	20 m
Density of treated fluid	1 Kg/dm³
Acoustic pressure max	<70dB
Max starts per hour	30

Construction materials

Case	Cast iron EN-GJL 250
Hydraulic parts	Cast iron EN-GJL 250
Impeller	Cast iron EN-GJL 250
Nuts and bolts	Stainless steel - Class A2-70
Standard gasket	Rubber - NBR
Shaft	Stainless steel - AISI 420
Grinding system	Chromium steel
Paint type	Ecological bicomponent epoxy (~ 80 µm)

Installations

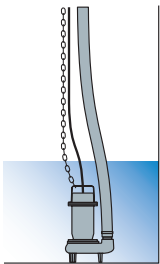

FREE

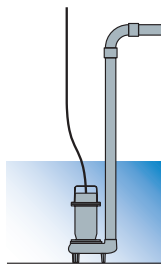

FIXED

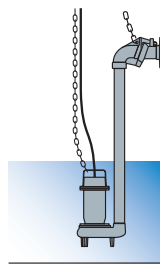

with EXTERNAL COUPLER

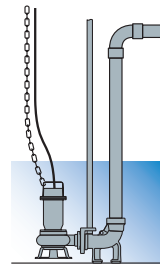

with BASE COUPLING FOOT

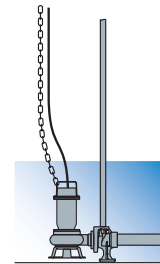

GR bluePRO 2/G40H

Performances

	l/s	0	1	2	3	4	5
	l/min	0	60	120	180	240	300
	m ³ /h	0	3.6	7.2	10.8	14.4	18.0
① GR bluePRO 100/2/G40H A1CM(T)5		18.0	16.4	14.4	11.5	6.9	
② GR bluePRO 150/2/G40H A1CM(T)5		21.1	19.6	17.9	15.1	10.4	3.0
③ GR bluePRO 200/2/G40H A1CM(T)5		27.0	25.6	23.6	20.7	16.1	9.3

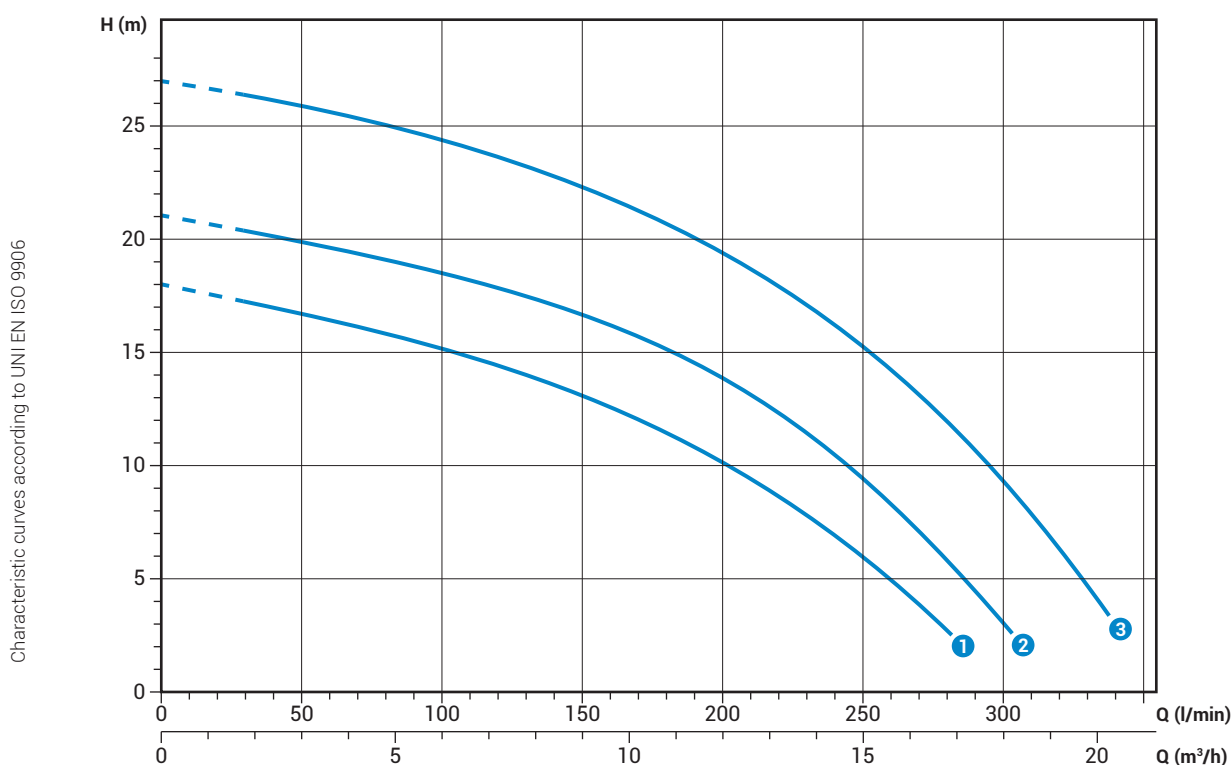

Technical data

	V	Phases	P1 (kW)	P2 (kW)	A	Rpm	Start	Cable	Ø	Free passage
① GR bluePRO 100/2/G40H A1CM5	230	1	-	0.74	5.5	2900	Dir	3G1	G 1½"-DN32	-
② GR bluePRO 150/2/G40H A1CM5	230	1	-	1.1	7.5	2900	Dir	3G1	G 1½"-DN32	-
③ GR bluePRO 200/2/G40H A1CM5	230	1	-	1.5	10	2900	Dir	3G1	G 1½"-DN32	-

	V	Phases	P1 (kW)	P2 (kW)	A	Rpm	Start	Cable	Ø	Free passage
① GR bluePRO 100/2/G40H A1CT5	400	3	-	0.74	2.7	2900	Dir	4G1	G 1½"-DN32	-
② GR bluePRO 150/2/G40H A1CT5	400	3	-	1.1	3.2	2900	Dir	4G1	G 1½"-DN32	-
③ GR bluePRO 200/2/G40H A1CT5	400	3	-	1.5	4.3	2900	Dir	4G1	G 1½"-DN32	-

GR bluePRO

Overall dimensions and weights

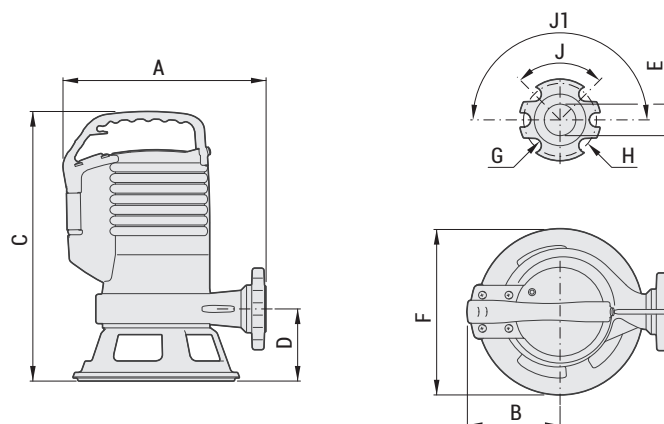

	A	B	C	D	E	F	G	H	J	J1	kg
GR bluePRO 100/2/G40H A1CM(T)5	270	130	365	95	G 1½"	220	14	90	90°	180°	19
GR bluePRO 150/2/G40H A1CM(T)5	285	125	410	100	G 1½"	230	14	90	90°	180°	24
GR bluePRO 200/2/G40H A1CM(T)5	285	125	410	100	G 1½"	230	14	90	90°	180°	25

Dimensions in mm

Packaging dimension



	X	Y	Z
GR bluePRO 100/2/G40H A1CM(T)5	300	250	400
GR bluePRO 150/2/G40H A1CM(T)5	300	250	440
GR bluePRO 200/2/G40H A1CM(T)5	300	250	440

Dimensions in mm

Pumps with high head impeller

Operating ranges

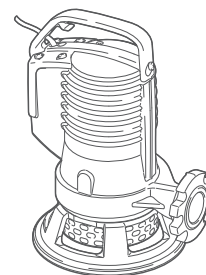
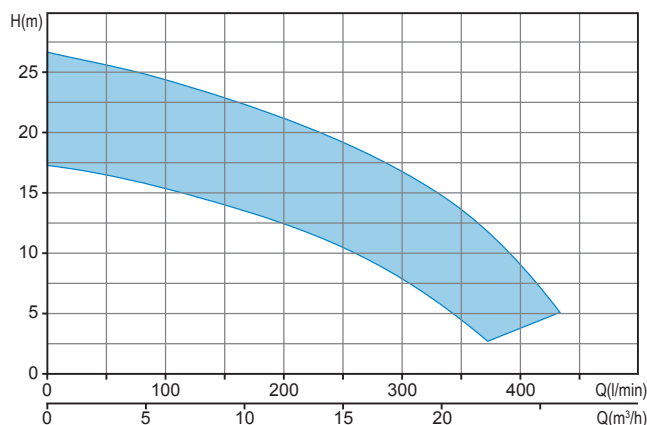

Range characteristics

Motor power	0.74 ÷ 1.5 kW
Poles	2
Insulation class	F
Degree of protection	IP68
Discharge	GAS 1 1/2" - DN32 horizontal
Free passage	6 mm
Max flow rate	7.1 l/s (426 l/min)
Max head	26.6 m

Motor

Dry motor with thermal protections.

Cable

H07RN-F - 5 m cable length. Optional 10 m cable length.

Mechanical seals

Two silicon carbide mechanical seals (2SiC), V-ring

Applications

Used for clear wastewater, rainwater and seepage containing small amounts of sand. Its high manometric head makes this series suitable for the creation of water features and decorative fountains. This electric pump is intended for both domestic and professional use.

Versions

Electrical variants	TC, TCG (single-phase models) TR, TRG (three-phase models)
Cooling system	N
Mechanical seals	2SiC

Operating specifications

Max operating temperature	40 °C
PH of treated fluid	6 ÷ 14
Viscosity of treated fluid	1 mm ² /s
Maximum immersion depth	20 m
Density of treated fluid	1 Kg/dm ³
Acoustic pressure max	<70dB
Max starts per hour	30

Construction materials

Case	Cast iron EN-GJL 250
Hydraulic parts	Cast iron EN-GJL 250
Impeller	Cast iron EN-GJL 250
Nuts and bolts	Stainless steel - Class A2-70
Standard gasket	Rubber - NBR
Shaft	Stainless steel - AISI 420
Paint type	Ecological bicomponent epoxy (~ 80 µm)

Installations

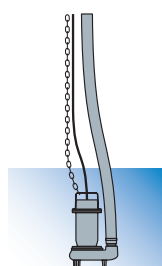

FREE

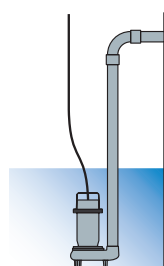

FIXED

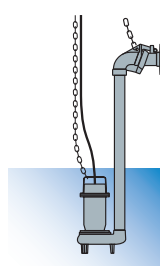

with EXTERNAL COUPLER

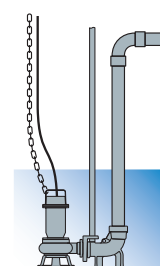

with BASE COUPLING FOOT

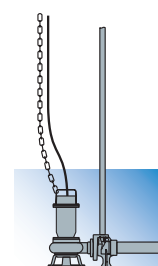

AP bluePRO 2/G40H

Performances

	l/s	0	1	2	3	4	5	6	7
	l/min	0	60	120	180	240	300	360	420
	m ³ /h	0	3.6	7.2	10.8	14.4	18.0	21.6	25.2
① AP bluePRO 100/2/G40H A1CM(T)5		17.3	16.3	14.9	13.1	10.9	7.8	3.6	
② AP bluePRO 150/2/G40H A1CM(T)5		20.9	19.8	18.5	16.7	14.6	11.7	7.8	
③ AP bluePRO 200/2/G40H A1CM(T)5		26.6	25.4	23.8	21.9	19.6	16.7	12.7	6.6

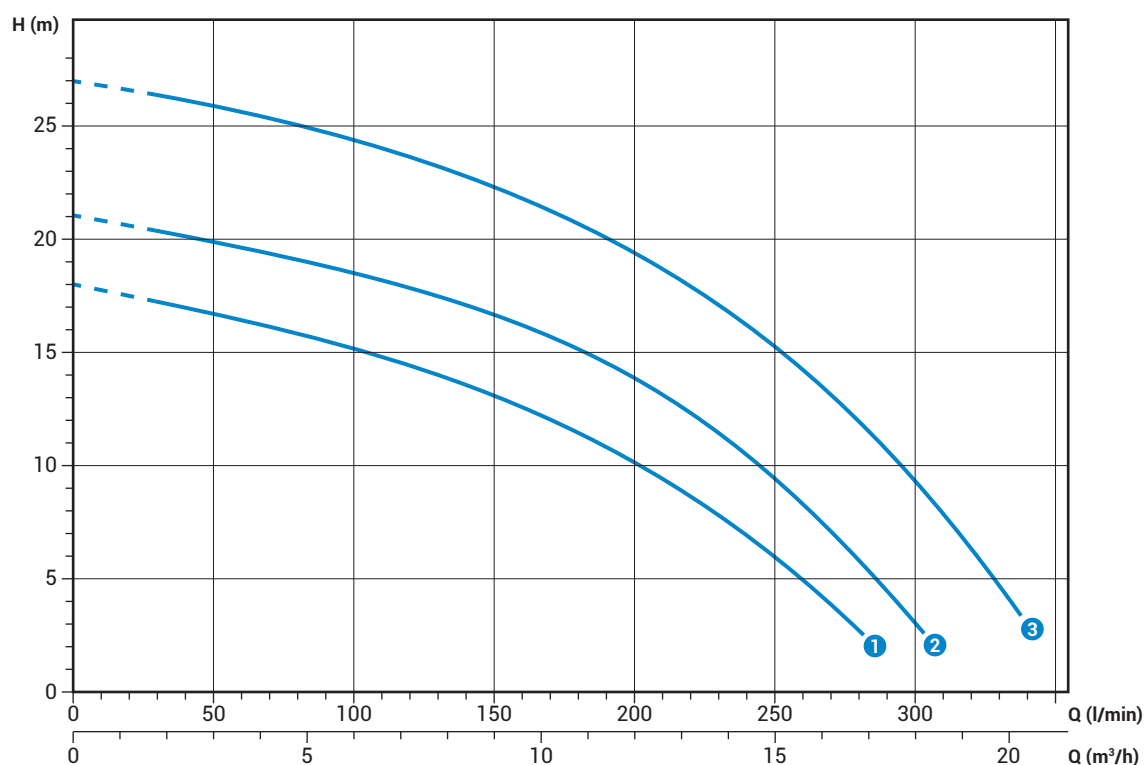

Characteristic curves according to UNI EN ISO 9906

Technical data

	V	Phases	P1 (kW)	P2 (kW)	A	Rpm	Start	Cable	Ø	Free passage
① AP bluePRO 100/2/G40H A1CM5	230	1	-	0.74	5.5	2900	Dir	3G1	G 1½"-DN32	-
② AP bluePRO 150/2/G40H A1CM5	230	1	-	1.1	7.5	2900	Dir	3G1	G 1½"-DN32	-
③ AP bluePRO 200/2/G40H A1CM5	230	1	-	1.5	10	2900	Dir	3G1	G 1½"-DN32	-

	V	Phases	P1 (kW)	P2 (kW)	A	Rpm	Start	Cable	Ø	Free passage
① AP bluePRO 100/2/G40H A1CT5	400	3	-	0.74	2.7	2900	Dir	4G1	G 1½"-DN32	-
② AP bluePRO 150/2/G40H A1CT5	400	3	-	1.1	3.2	2900	Dir	4G1	G 1½"-DN32	-
③ AP bluePRO 200/2/G40H A1CT5	400	3	-	1.5	4.3	2900	Dir	4G1	G 1½"-DN32	-

AP bluePRO 2/G40H

Overall dimensions and weights

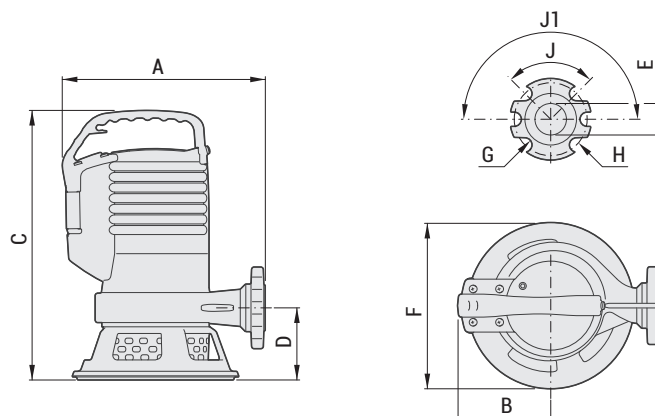

	A	B	C	D	E	F	G	H	J	J1	kg
AP bluePRO 100/2/G40H A1CM(T)5	270	130	365	95	G 1½"	220	14	90	90°	180°	19
AP bluePRO 150/2/G40H A1CM(T)5	270	130	365	95	G 1½"	220	14	90	90°	180°	24
AP bluePRO 200/2/G40H A1CM(T)5	270	130	365	95	G 1½"	220	14	90	90°	180°	26

Dimensions in mm

Packaging dimension



	X	Y	Z
AP bluePRO 100/2/G40H A1CM(T)5	300	250	400
AP bluePRO 150/2/G40H A1CM(T)5	300	250	440
AP bluePRO 200/2/G40H A1CM(T)5	300	250	440

Dimensions in mm

Hydraulic performance data

For quick, easy reference

DG blue

	0	1	2	3	4	5	6	7
	0	60	120	180	240	300	360	420
	0	3.6	7.2	10.8	14.4	18.0	21.6	25.2
DG blue 40/2/G40V A1BM5	6.0	5.2	4.0	2.8	1.7			
DG blue 50/2/G40V A1BM5	7.6	6.7	5.5	4.2	2.9	1.6		
DG blue 75/2/G40V A1BM5	10.1	9.5	8.5	7.2	5.7	4.2	2.6	
DG blue 100/2/G40V A1BM5	11.6	11.2	10.2	9.1	7.6	6.0	4.3	2.7

DR blue

	0	1	2	3	4	5
	0	60	120	180	240	300
	0	3.6	7.2	10.8	14.4	18.0
DR blue 40/2/G32V A1BM5	7.0	6.3	5.1	3.6		
DR blue 50/2/G32V A1BM5	9.5	8.4	7.0	5.1	2.7	
DR blue 75/2/G32V A1BM5	12.0	10.8	9.3	7.3	5.0	
DR blue 100/2/G32V A1BM5	14.2	13.3	11.9	10.3	8.0	4.5

DG bluePRO

	0	1	2	3	4	5	6	7	8	9	10	11	12
	0	60	120	180	240	300	360	420	480	540	600	660	720
	0	3.6	7.2	10.8	14.4	18.0	21.6	25.2	28.8	32.4	36.0	39.6	43.2
DG bluePRO 50/2/G40V A1BM(T)5	7.0	6.0	4.9	3.6	2.4	1.1							
DG bluePRO 75/2/G40V A1BM(T)5	10.2	9.1	8.0	6.7	5.5	4.0	2.6						
DG bluePRO 100/2/G40V A1BM(T)5	11.4	10.7	9.8	8.7	7.4	5.9	4.4	2.7					
DG bluePRO 150/2/G50V A1CM(T)5	12.3	11.5	10.7	9.7	8.8	7.6	6.5	5.3	4.4	3.3	2.4		
DG bluePRO 200/2/G50V A1CM(T)5	15.3	14.6	13.7	12.7	11.7	10.6	9.4	8.2	7.1	5.9	4.7	3.5	2.5

DR bluePRO

	0	1	2	3	4	5	6	7	8	9	10	11
	0	60	120	180	240	300	360	420	480	540	600	660
	0	3.6	7.2	10.8	14.4	18.0	21.6	25.2	28.8	32.4	36.0	39.6
DR bluePRO 50/2/G32V A1BM(T)5	8.7	7.9	6.8	5.2	3.4							
DR bluePRO 75/2/G32V A1BM(T)5	12.3	11.3	10.0	8.2	5.3							
DR bluePRO 100/2/G32V A1BM(T)5	14.6	13.5	12.1	10.1	7.4	3.0						
DR bluePRO 150/2/G50V A1CM(T)5	14.4	13.5	12.6	11.8	10.9	9.9	8.9	7.8	6.5	5.0	3.1	
DR bluePRO 200/2/G50V A1CM(T)5	17.0	16.2	15.3	14.3	13.3	12.1	10.9	9.5	8.1	6.6	5.1	3.3

GR bluePRO

	0	1	2	3	4	5
	0	60	120	180	240	300
	0	3.6	7.2	10.8	14.4	18.0
GR bluePRO 100/2/G40H A1CM(T)5	18.0	16.4	14.4	11.5	6.9	
GR bluePRO 150/2/G40H A1CM(T)5	21.7	19.6	17.9	15.1	10.4	3.0
GR bluePRO 200/2/G40H A1CM(T)5	27.0	25.6	23.6	20.7	16.1	9.3

AP bluePRO

	0	1	2	3	4	5	6	7
	0	60	120	180	240	300	360	420
	0	3.6	7.2	10.8	14.4	18.0	21.6	25.2
AP bluePRO 100/2/G40H A1CM(T)5	17.3	16.3	14.9	13.1	10.9	7.8	3.6	
AP bluePRO 150/2/G40H A1CM(T)5	20.9	19.8	18.5	16.7	14.6	11.7	7.8	
AP bluePRO 200/2/G40H A1CM(T)5	26.6	25.4	23.8	21.9	19.6	16.7	12.7	6.6



water solutions

All data made available remain non-binding.
Zenit reserves the right to make unannounced product changes it deems appropriate.

Rev. 0 - 01/03/17