

Self-cooling, Motor-independent
Frequency Inverter

PumpDrive 2 / PumpDrive 2 Eco

Type Series Booklet



Legal information/Copyright

Type Series Booklet PumpDrive 2 / PumpDrive 2 Eco

All rights reserved. The contents provided herein must neither be distributed, copied, reproduced, edited or processed for any other purpose, nor otherwise transmitted, published or made available to a third party without the manufacturer's express written consent.

Subject to technical modification without prior notice.

© KSB SE & Co. KGaA, Frankenthal 04/11/2020

Contents

Pump Control Systems.....	4
Variable Speed Systems	4
PumpDrive 2 / PumpDrive 2 Eco	4
Main applications.....	4
General description.....	4
Designation	4
Materials.....	6
Power range and sizes	6
Mounting options	7
Applications.....	7
Technical data	7
PumpDrive 2, motor-mounted / wall-mounted / cabinet-mounted models (enclosure IP55)	9
PumpDrive 2 Eco, motor-mounted / wall-mounted / cabinet-mounted models (enclosure IP55)	10
Optional components	10
Functions.....	12
Control panel.....	15
Dimensions and weights.....	15
Project planning information.....	18
Accessories.....	23
PumpMeter.....	35
General description.....	35
Main applications.....	35
Technical data	35
Materials.....	36
Product benefits.....	36
Functions.....	36
Design variants	38
Electrical connections.....	38
PumpMeter.....	38

Pump Control Systems

Variable Speed Systems

PumpDrive 2 / PumpDrive 2 Eco



Main applications

PumpDrive 2

- Air-conditioning systems
- Heat generation / heat distribution
- Water supply systems
- Water extraction / water withdrawal
- Water treatment / water conditioning
- Water distribution / water transport
- Refrigeration / cooling distribution
- Heat generation / heat distribution
- Fluid transport
- Cooling lubricant distribution
- Service water supply
- Tank drainage
- Waste water transport

PumpDrive 2 Eco

- Air-conditioning systems
- Heat generation / heat distribution
- Water supply systems

General description

Modular self-cooling frequency inverter that enables continuously variable speed control of asynchronous and synchronous reluctance motors by means of analog standard signals, a field bus or the control panel. As PumpDrive is self-cooling, it can be mounted on a motor, on the wall or in a control cabinet. Up to six pumps can be controlled without needing an additional controller.

Designation

Designation example

Position																													
1	2	3	4	5	6	7	8	9	10	11	12	13	14	15	16	17	18	19	20	21	22	23	24	25	26	27	28	29	30
P	D	R	V	2	I	-	0	1	1	K	0	0	M	-	K	S	U	P	B	E	S	P	2	-	O	O	O	O	O

Designation key

Position	Code	Description	MyFlow Drive	PumpDrive 2 Eco	PumpDrive 2
1-5	Product generation				
	PDRV2	PumpDrive 2	X	X	X
6	Design				
	E	PumpDrive 2 Eco	-	X	-
	I	MyFlow Drive	X	-	-
	-	PumpDrive 2	-	-	X
7	Product certifications				
	-	CE	X ¹⁾	X	-
	R	UR and CE	X ²⁾	-	X

¹ Available only for sizes ≤ 11 kW

² Available only for sizes 15 kW to 45 kW

Position	Code	Description	MyFlow Drive	PumpDrive 2 Eco	PumpDrive 2
7	L	UL and CE	-	-	X ³⁾
8-13	Power				
	A	000K37 = 0,37 kW	-	X	X
		000K55 = 0,55 kW	X	X	X
		000K75 = 0,75 kW	X	X	X
		001K10 = 1,1 kW	X	X	X
		001K50 = 1,5 kW	X	X	X
	B	002K20 = 2,2 kW	X	X	X
		003K00 = 3 kW	X	X	X
		004K00 = 4 kW	X	X	X
	C	005K50 = 5,5 kW	X	X	X
		007K50 = 7,5 kW	X	X	X
		011K00 = 11 kW	X	X	X
	D	015K00 = 15 kW	X	-	X
		018K50 = 18,5 kW	X	-	X
		022K00 = 22 kW	X	-	X
		030K00 = 30 kW	X	-	X
	E	037K00 = 37 kW	X	-	X
045K00 = 45 kW		X	-	X	
055K00 = 55 kW		-	-	X	
14	Mounting option				
	M	Motor mounting	X	X	X
	W	Wall mounting	-	X	X
	C	Cabinet mounting	-	X	X
16	Motor manufacturer				
	K	KSB	X	X	X
	S	Siemens	-	X	X
	C	Cantoni	-	X	X
	W	Wonder	-	X	X
17-20	Motor type				
	1LE1	Siemens 1LE1/ KSB 1PC3	-	X	X
	1LA7	Siemens 1LA7/ KSB 1LA7	-	X	X
	1LA9	Siemens 1LA9/ KSB 1LA9	-	X	X
	1LG6	Siemens 1LG6/ KSB 1LG6	-	X	X
	SUPB	KSB SuPremE B	X	X	X
	DMC	KSB(DM) Cantoni	-	X	X
	DMW	KSB(DM) Wonder	-	X	X
21-22	Efficiency class				
	E1	IE1	-	X	X
	E2	IE2	-	X	X
	E3	IE3	-	X	X
	E4	IE4	X	X	X
	E5	IE5	X	X	X
23-24	Number of motor poles				
	P2	2 poles	X	X	X
	P4	4 poles	X	X	X
	P6	6 poles	-	X	X
26	M12 module				
	O	None	X	X	X
	M	M12 module	-	X	X
27	Field bus module				
	O	None	X	X	X
	L	LON	-	-	X

³ Available on request only

Position	Code	Description	MyFlow Drive	PumpDrive 2 Eco	PumpDrive 2
27	P	Profibus DP	-	-	X
	M	Modbus RTU	X ⁴⁾	X	X
	B	BACnet MS / TP	-	X	X
	N	Profinet	-	X	X
28	Optional component 1				
	O	None	X	X	X
	I	I/O extension board	-	-	X
29	Optional component 2				
	O	None	X	X	X
	R	Bluetooth module	-	X	X
30	Optional component 3				
	O	None	X	X	X
	M	Master switch	-	-	X

Materials

Housing materials

Description	PumpDrive 2	PumpDrive 2 Eco
Housing cover	Die-cast aluminium	Polyamide, glass-fibre reinforced
Control panel	Polyamide, glass-fibre reinforced	Polyamide, glass-fibre reinforced
Heat sink	Die-cast aluminium	Die-cast aluminium
Slot covers	Polyamide, glass-fibre reinforced	Polyamide, glass-fibre reinforced
Cable glands	Polyamide	Polyamide

The parts of the frequency inverter housing which are in contact with the atmosphere are free from paint-wetting impairment substances.

Power range and sizes

Power range⁵⁾ for 2-pole (3000 rpm), 4-pole (1500 rpm) and 6-pole (1000 rpm) asynchronous motors and KSB SuPremE

Size	Nominal electrical power	Nominal output current	Mains input current
	[kW]	[A]	[A]
A	0,37	1,3	1,5
	0,55	1,8	2
	0,75	2,5	2,7
	1,10	3,5	3,7
	1,50	4,9	5,2
B	2,2	6	6,3
	3,0	8	8,4
	4,0	10	10,4
C	5,5	14	14,6
	7,5	18	18,7
	11	25	25,9
D	15	34,5	35,7
	18,5	44	45,4
	22	51	52,4
	30	68	69,7
E	37	84	85,9
	45	101	103,1
	55	120	122,4

⁴ Consult the manufacturer.

⁵ The power ranges specified apply in full to all mounting options.

Mounting options

The frequency inverter is identical in design and configuration for all 3 mounting options. PumpDrive 2 can be motor-mounted for the entire power range from 0.37 kW to 55 kW.

Motor mounting: The frequency inverter is mounted to the motor with an adapter or to the pump for the Movitec configuration. Adapters for subsequent conversion to the motor mounting configuration for existing pump systems are available as accessories.

Wall / control cabinet mounting: Installation kits for subsequent conversion to the wall / control cabinet mounting configuration for existing pump systems are available as accessories.

Applications

Possible combinations of pump and frequency inverter

Pump	Motor manufacturer	Motor-mounted model (with suitable adapters)	Wall-mounted model	Cabinet-mounted model
Amarex KRT	KSB	-	X	X
Etaline	<ul style="list-style-type: none"> ▪ KSB SuPremE B2/C2 motor IE4/IE5 ▪ Siemens motor, IE2, IE3 	X	X	X
Etaline-R		X	X	X
Etaline Z		X	X	X
Etabloc		X	X	X
Etanorm		X	X	X
Etachrom		X	X	X
HPK-L		X	X	X
MegaCPK		X	X	X
Multitec		X	X	X
Omega		X	X	X
Sewatec		X	X	X
Sewabloc		-	X	X
Vitachrom		X	X	X
Movitec		KSB (DM) <ul style="list-style-type: none"> ▪ Cantoni motor ▪ Wonder motor (up to 7.5 kW) ▪ Siemens motor (11 kW and above with thrust bearing housing), IE2, IE3 	X ⁶⁾	X
UPA	KSB	-	X	X

Motor-independent frequency inverter

Motor manufacturer	Motor-mounted model (with suitable adapters)	Wall-mounted model	Cabinet-mounted model
Supplier-neutral ⁷⁾	Mounted on the motor on request as it must be checked whether the available motor adapters fit.	X	X

Technical data

Technical data

Characteristic	PumpDrive 2 Eco	PumpDrive 2
Mains supply		
Mains voltage ⁸⁾	1~: 230 V AC +/- 15 % (0.55 and 1.1 kW) 3~: 380 V AC -10 % to 480 V AC +10 % (0.37 to 11.0 kW)	3~ 380 V alternating current -10 % to 480 V alternating current +10 %
Voltage difference between the three phases	±2 % of the supply voltage	
Mains frequency	50 - 60 Hz ± 2 %	
Mains types	TN-S, TN-CS, TN-C, TT and IT mains (to IEC/EN 60364)	
Output data		
Frequency inverter output frequency	0 - 70 Hz for asynchronous motors 0 - 140 Hz for KSB SuPremE	
PWM carrier frequency	Range: 2 - 8 kHz (Factory setting: 4 kHz)	

⁶⁾ Frequency inverter is mounted on pump flange.

⁷⁾ Standard asynchronous motors to IEC 60072/ IEC 60034. (The motor used must be suitable for use with a frequency inverter).

⁸⁾ If the mains voltage is low, the nominal torque of the motor will be lower.

Characteristic	PumpDrive 2 Eco	PumpDrive 2
Phase rate of rise dv/dt^9	5000 V/ μ s maximum, depending on the size of the frequency inverter	
Peak voltages	$2 \times 1,41 \times V_{eff}$ Electric cables with a high current-carrying capacity can cause the voltage to increase up to double the value.	
Frequency inverter data		
Efficiency	98 % - 95 % ¹⁰⁾	
Noise emissions	Sound pressure level of pump used + 2.5 dB ¹¹⁾	
Environment		
Enclosure	IP55 (to EN 60529)	
In-service ambient temperature	-10 °C to +50 °C	
In-storage ambient temperature	-10 °C to +70 °C	
Relative humidity	In service: 5 % to 85 %, non-condensing Storage: 5 % to 95 % Transport: 95 % max.	
Installation altitude	<ul style="list-style-type: none"> ▪ < 1000 m above MSL, or 1 % power derating per additional 100 m ▪ Maximum installation altitude 2000 m above MSL 	
Vibration resistance	16.7 m/s ² max. (to EN 60068-2-64)	
Fluid temperature ¹²⁾	-90 °C to +140 °C	
EMC		
Frequency inverter \leq 11 kW	EN 61800-3 C1 / EN 55011 Class B / cable length \leq 5 m	
Frequency inverter $>$ 11 kW	EN 61800-3 C2 / EN 55011 Class A, Group 1 / cable length \leq 50 m	
Mains feedback	Integrated line chokes	
Inputs and outputs		
Internal power supply unit	24 V \pm 10 %	
Maximum load	600 mA DC max., short-circuit-proof and overload-proof	
Residual ripple	< 1 %	
Analog inputs		
Number of parameterisable analog inputs	2 (configurable for current or voltage input)	
Input type	Not differential	Differential
Maximum voltage (with reference to GND)	+10 V	\pm 10 V
Current input	0/4...20 mA	
Input impedance	500 Ω	
Accuracy	1 % of full-scale value	
Signal delay	< 10 ms	
Resolution	12 bit	
Voltage input	0/2...10 V	
Input impedance	Approx. 160 kOhm	Approx. 40 kOhm
Accuracy	1 % of full-scale value	
Signal delay	< 10 ms	
Resolution	12 Bit	
Reverse polarity protection	Not provided	Positive and negative polarity reversal possible
Analog outputs		
Number of parameterisable analog outputs	1 (toggling 4 output values)	
Current output	4...20 mA	
Maximum external working resistance	850 Ω	
Output	PNP transistor	
Accuracy	2 % of full-scale value	
Signal delay	< 10 ms	
Reverse polarity protection	Provided	

⁹ The phase rate of rise (dv/dt) depends on the line capacity.

¹⁰ The efficiency at the nominal point of the frequency inverter varies between 98 % for high power outputs and 95 % for low outputs, depending on the inverter's nominal power.

¹¹ The values are for orientation purposes only. The value refers to the nominal duty point (50 Hz) only. Also refer to the pump's noise characteristics. They, too, are documented for nominal duty operation. Other values may occur during variable speed operation.

¹² Provided the specified ambient temperature limits are complied with.

Characteristic	PumpDrive 2 Eco	PumpDrive 2
Short-circuit protection and overload protection	Provided	
Digital inputs		
Number of digital inputs	4 in total, 3 of which can be parameterised	6 in total, 5 of which can be parameterised
ON level	15...30 V	
OFF level	0...3 V	
Input impedance	Approx. 2 kOhm	
Galvanic isolation	Provided, isolation voltage: 500 V AC	
Delay	< 10 ms	
Reverse polarity protection	Provided	
Relay outputs		
Number of parameterisable relay outputs	2 NO contacts	2 changeover contacts
Maximum contact rating	AC: max. 250 V AC/0.25 A DC: max. 30 V DC/2 A	

PWM carrier frequency

Power derating for increased carrier frequency

(at PWM carrier frequency > 4 kHz): $I_{\text{Nominal motor current (PWM)}} = I_{\text{Nominal motor current}} \times (1 - [f_{\text{PWM}} - 4 \text{ kHz}] \times 2.5 \%)$

PumpDrive 2, motor-mounted / wall-mounted / cabinet-mounted models (enclosure IP55)

PumpDrive 2, motor-mounted / wall-mounted / cabinet-mounted models (enclosure IP55)

Housing type	P _N PumpDrive (parameters not pre-set) + control panel (graphical)		[kg] ¹³⁾
	[kW]	Mat. No.	
A	0,37	01608493	5
A	0,55	01608494	5
A	0,75	01608495	5
A	1,10	01608496	5
A	1,50	01608497	5
B	2,20	01608498	6,5
B	3,00	01608499	6,5
B	4,00	01608500	6,5
C	5,50	01608501	12,6
C	7,50	01608502	12,6
C	11,00	01608503	12,6
D	15,00	01608504	27,6
D	18,50	01608505	36
D	22,00	01608506	36
D	30,00	01608508	36
E	37,00	01608509	57,6
E	45,00	01608510	60
E	55,00	01608511	60

Optional

- M12 module
- Profibus DP
- LON
- BACnet MS / TP
- Profinet
- Modbus RTU
- Bluetooth module
- Integrated master switch
- I/O extension board

¹³⁾ Without motor adapter

PumpDrive 2 Eco, motor-mounted / wall-mounted / cabinet-mounted models (enclosure IP55)

PumpDrive 2 Eco, motor-mounted / wall-mounted / cabinet-mounted models (enclosure IP55)

Housing type	P _N PumpDrive (parameters not pre-set) + control panel (standard)		[kg] ¹⁴⁾
	[kW]	Mat. No.	
A	0,37	01608513	4
A	0,55	01608514	4
A	0,75	01608515	4
A	1,10	01608516	4
A	1,50	01608517	4
B	2,20	01608518	5,5
B	3,00	01608519	5,5
B	4,00	01608520	5,5
C	5,50	01608521	10,5
C	7,00	01608522	10,5
C	11,00	01608523	10,5

Optional

- M12 module¹⁵⁾
- Profibus DP¹⁵⁾
- BACnet MS / TP¹⁵⁾
- Profinet¹⁵⁾
- Modbus RTU¹⁵⁾
- Bluetooth module

Optional components



Fig. 1: PumpDrive 2¹⁶⁾ optional components

1	Master switch	2	M12 module
3	Profibus DP LON BACnet MS/TP Profinet Modbus RTU	4	Bluetooth module
5	I/O extension board		

¹⁴ Without motor adapter

¹⁵ PumpDrive 2 Eco has only got one slot. This is where the M12 module or the corresponding field bus module can be inserted.

¹⁶ Optional components can be fitted at the factory or retrofitted.

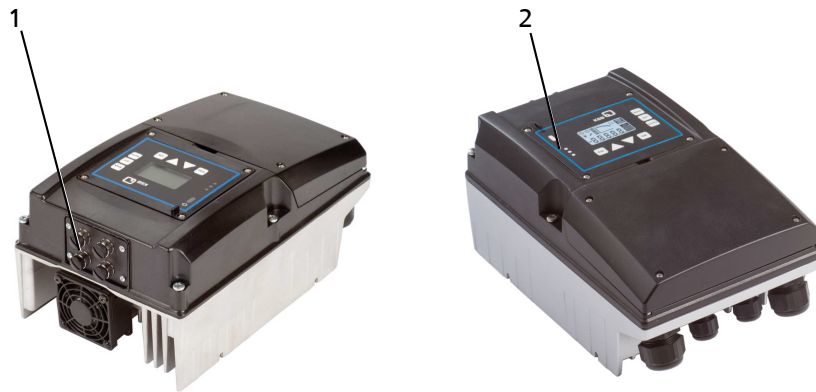

Fig. 2: PumpDrive 2 Eco¹⁶⁾ optional components

1	M12 module or Modbus RTU Profibus DP BACnet MS/TP Profinet	2	Bluetooth module
---	---	---	------------------

M12 module

- Connection of several PumpDrive 2 (for dual-pump configuration / multiple pump configuration) via M12 module
- PumpMeter connection to PumpDrive 2 via Modbus using the M12 module
- Can be retrofitted
- Internal T-connector (bus looped through); uninterruptible even in the event of a frequency inverter power failure
- Pre-configured cables (⇒ Page 23)

Bluetooth module

- For communication with a smartphone/tablet (Android or iOS)
- Can be retrofitted
- Bluetooth 2.0 (range approx. 10 m, compatible from iOS 8)
- Installation in control panels of PumpDrive 2 / PumpDrive 2 Eco

Basic functions of the KSB FlowManager app¹⁷⁾:

- Operation and monitoring
- Commissioning wizard
- Management of data records
- Updating software

Field bus module

- Field bus modules (plug-in modules) for Profibus DP, Modbus RTU, LON, BACnet MS/TP and Profinet
- Can be retrofitted
- Internal T-connector (bus looped through), uninterruptible¹⁸⁾ even in the event of a frequency inverter power failure

¹⁷ The KSB FlowManager app is available for download from the App Store and Google Play Store free of charge.

¹⁸ This function does not apply when the Profinet module is connected in a bus topology.

Master switch (optional)

Continuous current, master switch by size

Size	Continuous current, master switch
	[A]
A	10
B	16
C	40
D	80
E	160

- Can be locked
- Retrofit kit comprising master switch, housing components with master switch cutout and installation accessories
- Voltage 400 V

I/O extension board (optional)

- Installation at the factory or retrofittable as accessory
- Installation in the frequency inverter

Additional inputs / outputs:

- 1 analog input
- 1 analog output
- 3 digital inputs
- 2 digital outputs
- 1 changeover contact relay
- 5 NO contact relays

Functions

Overview of functions

Functions / firmware	PumpDrive 2	PumpDrive 2 Eco
Protective functions		
Thermal motor protection	X	X
Mains voltage monitoring	X	X
Phase failure, motor side	X	X
Short-circuit monitoring, motor side (phase to phase and phase to earth)	X	X
Dynamic overload protection by speed limitation (i ² t control)	X	X
Resonant frequency suppression	X	X
Broken wire detection (live zero)	X	X
Protection against dry running and hydraulic blockage (sensorless due to learning function)	X	X
Dry running protection (external control signal)	X	X
Operating point estimation and characteristic curve control	X	X
Open-loop control		
Open-loop control mode	X	X
Closed-loop control		
Closed-loop control mode via integrated PID controller	X	X
Pressure control / differential pressure control (Δp const)	X	X
Pressure control / differential pressure control with dynamic pressure compensation (Δp var)	X	X
Flow rate control	X	X
Sensorless differential pressure control (Δp const) in a single-pump configuration	X	X
Sensorless differential pressure control with dynamic pressure compensation (Δp var) in a single-pump configuration	X	X
Sensorless flow rate control	X	X
Level control	X	X
Temperature control	X	X
Alternative setpoint	X	-
Operation and monitoring (display)		

Functions / firmware	PumpDrive 2	PumpDrive 2 Eco
Measured value display (pressure, head, speed, electric power, motor voltage, motor current, torque)	X	X
Fault history	X	X
Operating hours counter	X	X
Fault reporting via relay	X	X
Frequency inverter functions		
Programmable start ramps and stop ramps	X	X
Field-oriented control (vector control), V/f control	X	X
Configurable motor control method (asynchronous motor, KSB SuPremE)	X	X
Automatic motor adaptation (AMA)	X	X
Motor standstill heater	X	X
Manual-0-automatic mode	X	X
External OFF	X	X
External minimum speed	X	X
Sleep mode (stand-by mode)	X	X
Energy savings meter	X	-
Pump functions		
Flow rate estimation	X	X
M12 module with PumpMeter bus connection	X	X
M12 module for dual-pump configuration	X	X
M12 module for multiple pump configuration with up to 6 pumps	X	X
Functional check run	X	X
Deragging	X	X
Integrated dual-pump configuration (1x100 % with redundant pump or 2x50 % without redundant pump)	X	X
Multiple pump configuration with up to 6 pumps	X	X
Waste water function: start-up at maximum speed	X	-
Waste water function: rinsing function	X	-
Operation		
Control panel	X	X ¹⁹⁾
Commissioning wizard	X	X ²⁰⁾
Favourites list	X	-
Service interface	X	X

Protective functions

Sensorless protection against dry running and hydraulic blockage

Dry running of the pump is detected and the pump set is stopped before components are damaged.

Hydraulic blockage is also detected and initially a warning is displayed. If the blockage persists for a prolonged period of time, the pump set is stopped. These protective functions do not require sensors. They are based on an automatic learning function which needs to be run once during commissioning.

Dynamic overload protection by speed limitation (I²t control)

The frequency inverter is equipped with current sensors that record the motor current and enable motor current limitation. When the defined load limit or temperature limit is reached, the speed is lowered in order to reduce the power (I²t control). The frequency inverter then no longer operates in closed-loop control mode but maintains the operative function at a lower speed.

Characteristic curve control

The frequency inverter indicates continuous operation outside the permissible range, such as extremely low flow or extreme overload. The frequency inverter monitors the current operating point on the basis of the motor input power and the speed. In the case of extremely low flow or overload, a message is output and, depending on the settings, the pump set is switched off as required.

Open-loop and Closed-loop Control

Sensorless differential pressure control for single-pump configurations

The configurable differential pressure is kept almost constant over a broad operating range without the need for sensors. This can also be achieved using the dynamic pressure compensation function. The speed is adjusted as a function of the power input so that the required differential pressure is maintained.

Dynamic pressure/differential pressure compensation

The dynamic pressure/differential pressure compensation function compensates for pipe friction losses, which need to be considered if the pressure/differential pressure sensor is installed close to the pump or if sensorless differential pressure control is used. This ensures a virtually constant pressure/differential pressure at the consumer (e.g. heating) regardless of the flow. The

¹⁹ Some functions can only be parameterised and/or displayed using the KSB ServiceTool (see operating manual).

²⁰ Only available via KSB ServiceTool or app

dynamic pressure compensation function requires signals from two pressure sensors or one differential pressure sensor. Alternatively, sensorless dynamic differential pressure compensation can be used. The differential pressure setpoint is increased as a function of the (estimated or measured) flow rate or the speed.

Operation and monitoring

Display

Various physical data, such as the pressure, flow rate, speed, motor voltage, motor current, electric power, torque and others, can be displayed using the control panel or the service software.

Message history

The last 100 messages of the frequency inverter can be viewed. All messages are provided with a time stamp (real-time clock).

Statistics function

The frequency inverter generates utilisation statistics on the operating hours to date, runtime and number of starts.

Frequency inverter functions

Automatic motor adaptation

Automatic motor adaptation (AMA) is a method for measuring the electric parameters of the motor with the motor at a standstill. The frequency inverter's motor control method is optimised to ensure optimum motor performance and efficiency.

Motor control method

The frequency inverter's motor control method can be set for either an asynchronous motor or the KSB SuPremE motor.

Stand-by mode (sleep mode)

Sleep mode allows the single or multiple pump system to be started and stopped in line with demand. If sleep mode is activated, the frequency inverter stops the pump in the case of low flow rates, i.e. when the low flow limit or stop speed is reached. In pressure control applications, an accumulator can be filled during brief operation with an increased setpoint prior to stopping. If a drop in pressure and, thus, a flow rate requirement are detected, the pump restarts.

Pump functions

Direct connection to PumpMeter

PumpMeter can be connected to the M12 module of the frequency inverter via the Modbus interface using the M12 connector. Once they are connected, the frequency inverter and PumpMeter can automatically exchange all the data required for initialisation (pump characteristic curve, sensor data, etc.). This enables easy and straightforward commissioning, even in retrofit applications.

Deragging

If fluids with a high solids content are handled, deposits may form that may in turn impair pump operation or prevent start-up of the pump. The Deragging function serves to prevent deposits from forming in the pump, thus ensuring reliable operation. To this end, the pump is operated in the opposite direction to its normal direction of rotation at regular intervals in order to clean the hydraulic system.

Dual-pump configuration

The dual-pump configuration serves to control two pumps of identical design. Two operating modes can be set:

- In "1 pump" operating mode, the dual pump system is designed to achieve the setpoint with one pump operating at rated values (1 x 100 %).
- In "2 pumps" operating mode, the system's rated operating point is achieved with both pumps operating at rated values (2 x 50 %).

Both frequency inverters are quickly and easily connected to the respective M12 modules by way of pre-configured cables. The PumpMeter sensor signal can also be redundantly connected to the second frequency inverter as an option using a pre-configured "PumpMeter Crosslink" bus cable.

Multiple pump configuration

Up to six PumpDrives can be operated in parallel in a multiple pump configuration. One frequency inverter is used as master and controls all other available frequency inverters as slaves so that the operating point is as close as possible to the best efficiency point. If the master fails or malfunctions, the role of master can be assumed by one of the other frequency inverters. This requires, however, that the appropriate signals be made available in parallel at each frequency inverter. As with dual-pump operation, in a multiple pump configuration, the frequency inverters are quickly and easily connected to the M12 modules using pre-configured cables.

Energy-efficient pump starting and stopping

Pumps operated in a dual-pump or multiple pump configuration are started and stopped with a view to optimal efficiency. Based on the current operating point and the pump characteristic curves, the frequency inverter automatically decides when an additional pump should be started or stopped to ensure that the multiple pump system is operated as efficiently as possible.

Control panel

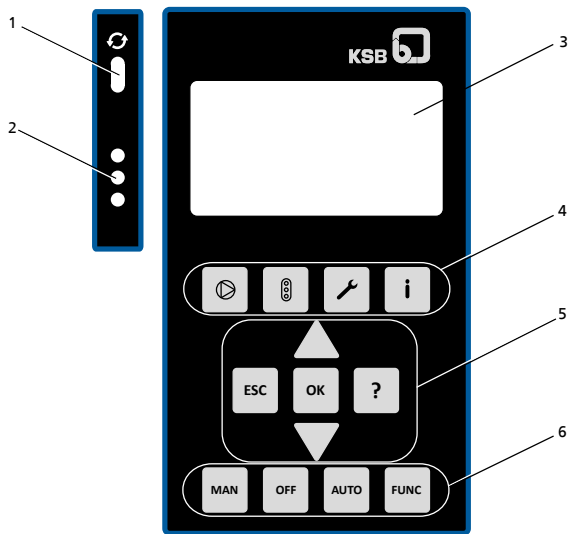

PumpDrive 2: Graphical control panel



PumpDrive 2 Eco: Standard control panel

Description of standard control panel

Position	Description	Function
1	Service interface	PumpDrive configuration and parameterisation via PC/notebook.
2	LED traffic light function	The traffic light function provides information about the pump system's operating status.
3	Display	PumpDrive 2 Eco: Standard control panel Display of the operating status, motor speed, setpoint and actual value via LEDs PumpDrive 2: Graphical control panel Display of the operating values, alerts and parameters in different national languages
4	Menu keys	Change to the elements of the first menu level
5	Navigation keys	Setpoint specification, parameter selection and confirmation
6	Operating keys	Toggling operating modes

Dimensions and weights

PumpDrive 2 Eco

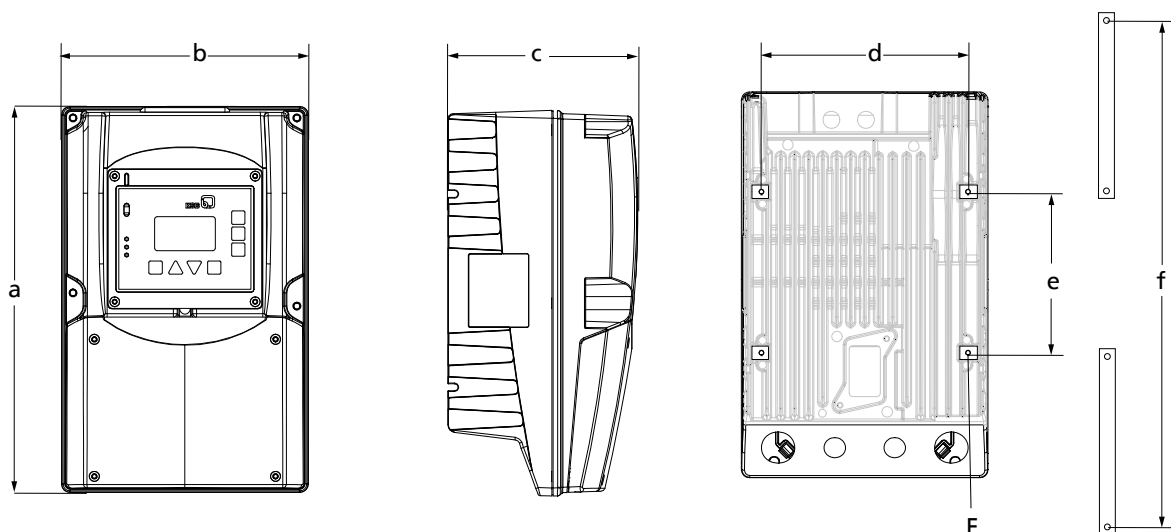

Fig. 3: PumpDrive 2 Eco dimensions

4074.5/06-EN

Dimensions and weights

Housing type	P _N	Motor-mounted model					Wall-mounted/ cabinet-mounted model ⁽²¹⁾					Fastening screws/bolts	[kg] ⁽²²⁾
		a	b	c	d	e	a	b	c	d	f	F	
	[kW]	[mm]										-	
A	0,37	260	171	144	140	141	343	171	144	140	333	M4 × 10	4
A	0,55	260	171	144	140	141	343	171	144	140	333	M4 × 10	4
A	0,75	260	171	144	140	141	343	171	144	140	333	M4 × 10	4
A	1,10	260	171	144	140	141	343	171	144	140	333	M4 × 10	4
A	1,50	260	171	144	140	141	343	171	144	140	333	M4 × 10	4
B	2,20	290	186	144	155	121	328	186	144	155	318	M4 × 10	5,5
B	3,00	290	186	144	155	121	328	186	144	155	318	M4 × 10	5,5
B	4,00	290	186	144	155	121	328	186	144	155	318	M4 × 10	5,5
C	5,50	330	255	185	219	205	401	255	185	219	387	M6 × 12	10,5
C	7,00	330	255	185	219	205	401	255	185	219	387	M6 × 12	10,5
C	11,00	330	255	185	219	205	401	255	185	219	387	M6 × 12	10,5

PumpDrive 2

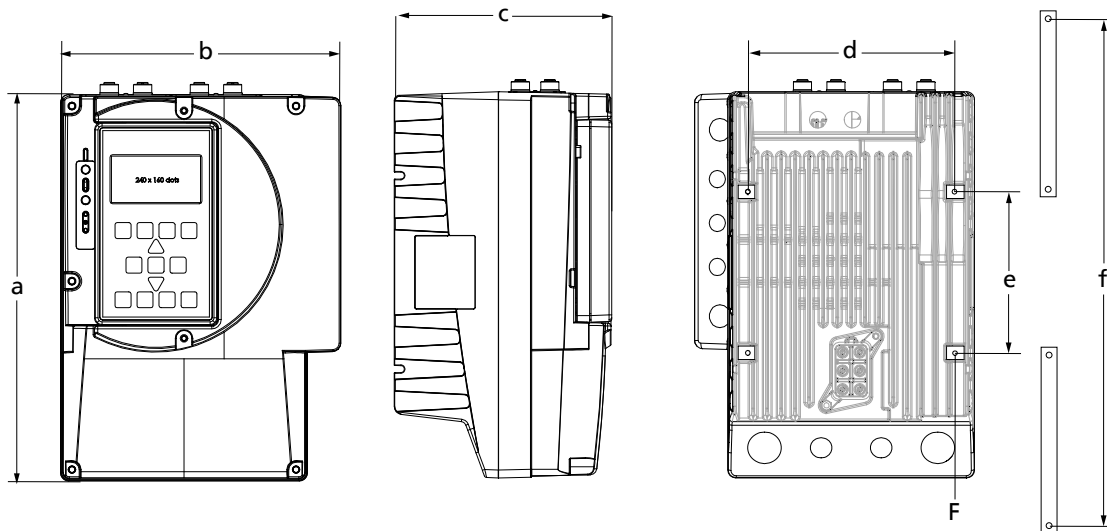

Fig. 4: PumpDrive 2 dimensions

Dimensions and weights

Housing type	P _N	Motor-mounted model					Wall-mounted/ cabinet-mounted model ⁽²³⁾					Fastening screws/bolts	[kg] ⁽²⁴⁾
		a	b	c	d	e	a	b	c	d	f	F	
	[kW]	[mm]										-	
A	0,37	260	190	166	140	141	343	190	166	140	333	M4 × 10	5
A	0,55	260	190	166	140	141	343	190	166	140	333	M4 × 10	5
A	0,75	260	190	166	140	141	343	190	166	140	333	M4 × 10	5
A	1,10	260	190	166	140	141	343	190	166	140	333	M4 × 10	5
A	1,50	260	190	166	140	141	343	190	166	140	333	M4 × 10	5
B	2,20	290	211	166	155	121	328	211	166	155	318	M4 × 10	6,5
B	3,00	290	211	166	155	121	328	211	166	155	318	M4 × 10	6,5
B	4,00	290	211	166	155	121	328	211	166	155	318	M4 × 10	6,5
C	5,50	330	280	210	219	205	401	280	210	219	387	M6 × 12	12,6
C	7,50	330	280	210	219	205	401	280	210	219	387	M6 × 12	12,6
C	11,00	330	280	210	219	205	401	280	210	219	387	M6 × 12	12,6

²¹ The dimensions provided refer to the frequency inverter including the wall-mounting brackets.

²² Without motor adapter

²³ The dimensions provided refer to the frequency inverter including the wall-mounting brackets.

²⁴ Without motor adapter

Housing type	P _N	Motor-mounted model					Wall-mounted/ cabinet-mounted model ²³⁾					Fastening screws/bolts	[kg] ²⁴⁾
		a	b	c	d	e	a	b	c	d	f	F	
	[kW]	[mm]										-	
D	15,00	460	350	290	280	309	582	350	290	280	565	M8 × 14	27,6
D	18,50	460	350	290	280	309	582	350	290	280	565	M8 × 14	36
D	22,00	460	350	290	280	309	582	350	290	280	565	M8 × 14	36
D	30,00	460	350	290	280	309	582	350	290	280	565	M8 × 14	36
E	37,00	700	455	340	375	475	819	455	340	375	800	M8 × 14	57,6
E	45,00	700	455	340	375	475	819	455	340	375	800	M8 × 14	60
E	55,00	700	455	340	375	475	819	455	340	375	800	M8 × 14	60

Project planning information

Power cables

Unshielded cables can be used as power cables.

The power cables must be designed with a cross-section suitable for the nominal mains current.

If a mains contactor is used in the power cable (before the frequency inverter), this must be configured for an AC1 duty rating; the rated current values of the frequency inverters used are added and the result is increased by 15 %.

Power cable properties

Size	Power [kW]	Cable gland for				Mains input current ²⁵⁾ [A]		Maximum core cross- section [mm ²]	Cable cross- section KSB motor power cable [mm ²]	
		Power cable	Sensor cable	Motor power cable	PTC thermistor	Variant for				
						400 V / 3~	230 V / 1~			
A	.. 000K37 ..	0,37	M20	M16	M20	M16	1,5	-	2,5	2,5
	.. 000K55 ..	0,55	M20	M16	M20	M16	2,0	4,0	2,5	2,5
	.. 000K75 ..	0,75	M20	M16	M20	M16	2,7	-	2,5	2,5
	..001K10..	1,1	M20	M16	M20	M16	3,7	6,0	2,5	2,5
	.. 001K50 ..	1,5	M25	M16	M25	M16	5,2	-	2,5	2,5
B	.. 002K20 ..	2,2	M25	M16	M25	M16	6,3	-	2,5	2,5
	.. 003K00 ..	3	M25	M16	M25	M16	8,4	-	2,5	2,5
	.. 004K00 ..	4	M25	M16	M25	M16	10,4	-	2,5	2,5
C	..005K500..	5,5	M32	M16	M32	M16	14,6	-	16	4
	..007K500..	7,5	M32	M16	M32	M16	18,7	-	16	4
	..011K000..	11	M32	M16	M32	M16	25,9	-	16	6
D	..15K000..	15	M40	M32	M40	M20	35,7	-	50	10
	..18K500..	18,5	M40	M32	M40	M20	45,4	-	50	16
	..22K00..	22	M40	M32	M40	M20	52,4	-	50	16
	..30K00..	30	M40	M32	M40	M20	69,7	-	50	25
E	..37K00..	37	M63	M32	M63	M20	85,9	-	95	35
	..45K00..	45	M63	M32	M63	M20	103,1	-	95	50
	..55K00..	55	M63	M32	M63	M20	122,4	-	95	70

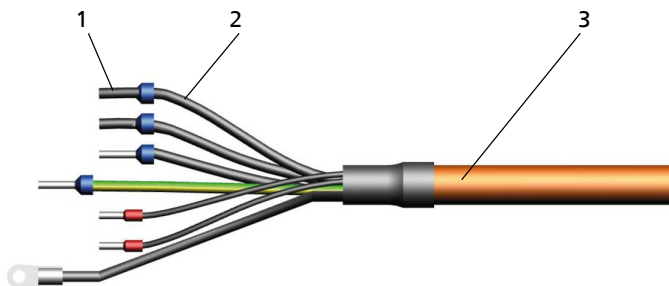

Fig. 5: Structure of electric cable

1	Wire end sleeve
2	Core
3	Cable

Cable cross-sections of control terminals

Control terminal	Core cross-section			Cable diameter ²⁶⁾ [mm]
	Rigid cores	Flexible cores	Flexible cores with wire end sleeves	
	[mm ²]			
Terminal strip A, B, C	0,2 - 1,5	0,2 - 1,0	0,25 - 0,75	M12: 3,5 - 7,0 M16: 5,0 - 10,0

²⁵ Observe the information on the use of line chokes provided in the Project planning information and Accessories sections.

²⁶ Impairment of protection provided by enclosure when cable diameters other than those specified are used.

Length of motor power cable

If the frequency inverter is not mounted on the motor to be controlled, longer motor power cables may be required. The stray capacitance of the connection cables may result in high-frequency discharge currents flowing to ground. The sum of the discharge currents and motor current may exceed the output-side rated current of the frequency inverter. This will activate the frequency inverter's protection equipment and the motor will be stopped. The following motor power cables are recommended depending on the power range:

Length of motor power cable

Power range	Cable length		Stray capacitance
	Max.		
[kW]	[m]		[nF]
≤ 11 (Class B)	5		≤ 5
≥ 15 (Class A, Group 1)	50		≤ 5

Output filters

Dv/dt output filters can be used in conjunction with an asynchronous motor and a KSB SuPremE motor. Sine filters can only be used in conjunction with an asynchronous motor. If the length or stray capacitance of the power cable exceed the values indicated, we recommend installing a suitable output filter between the frequency inverter and the motor to be controlled. These filters reduce the voltage ramp-up time of the frequency inverter output voltages and limit their peaks. (⇒ Page 21)

Electrical protection equipment

Cable protection

We recommend installing a miniature circuit breaker or suitable fuses for protecting the power cable of the frequency inverter with consideration of the input-side rated currents as per the following table. The protection must be able to withstand an overload current of 1.5 times the input-side rated current for 60 seconds. The fuse can be of type gG (IEC 60269) or a UL-equivalent with a response time below 0.5 seconds.

If voltage fluctuations are expected in the power supply, we recommend protecting the frequency inverter with fast acting fuses of type gR (IEC 60269) or UL-class JFHR2/JFHR8. The maximum permissible values for the clearing integral i^2t [A²s] indicated in the following table must be observed. The values for the clearing integral i^2t can vary strongly at the same rated power, depending on the manufacturer. For any deviating values, make sure they are smaller than or equal to the maximum permissible value indicated in the table.

Technical data of the overcurrent protective device

Size	Variant for		Power	Rated current I _{rms}	Rated voltage		Rated breaking capacity	Clearing integral Total i^2t @ AC 660 V	I _{peak}	
					IEC 60269-4	UL 248-13				
	400 V / 3~	230 V / 1~	[kW]	[A]	[V AC]		[kA]	[A ² s]	[A]	
A	.. 000K37 ..	X	-	0,37	20	690	700	200	168	600
	.. 000K55 ..	X	-	0,55	20	690	700	200	168	600
		-	X		5,5	500	-	180	6	16
	.. 000K75 ..	X	-	0,75	20	690	700	200	168	600
	.. 001K10..	X	-	1,1	20	690	700	200	168	600
		-	X		8	500	-	180	8	16
.. 001K50 ..	X	-	1,5	20	690	700	200	168	600	
B	.. 002K20 ..	X	-	2,2	20	690	700	200	168	600
	.. 003K00 ..	X	-	3	20	690	700	200	168	600
	.. 004K00 ..	X	-	4	20	690	700	200	168	600
C	..005K500..	X	-	5,5	50	690	700	200	945	1500
	..007K500..	X	-	7,5	50	690	700	200	945	1500
	..011K000..	X	-	11	50	690	700	200	945	1500
D	..15K000..	X	-	15	100	690	700	200	6319	2600
	..18K500..	X	-	18,5	100	690	700	200	6319	2600
	..22K00..	X	-	22	100	690	700	200	6319	2600
	..30K00..	X	-	30	100	690	700	200	6319	2600
E	..37K00..	X	-	37	160	690	700	200	5775	2100
	..45K00..	X	-	45	160	690	700	200	5775	2100
	..55K00..	X	-	55	160	690	700	200	5775	2100

Motor protection switch

Separate motor protection is not required because the frequency inverter has its own safety devices (e.g. electronic overcurrent trip). Available motor protection switches must be rated for 1.4 times the nominal motor current.

Residual current device

If fixed connections and appropriate supplementary earthing are used (to DIN VDE 0160), RCDs are not mandatory for frequency inverters.

If residual current devices (RCDs) are used, three-phase frequency inverters must in accordance with DIN VDE 0160 be connected via universal AC/DC sensitive residual current devices (RCDs), as potential direct-current components may cause standard AC sensitive RCDs to either fail to respond or respond erroneously.

Residual current device to be selected

Size	Rated current [mA]
A, B and C	150
D and E	300

If you are using a long shielded cable for the mains connection / motor connection, the residual-current monitoring device may be triggered by the discharge current that flows to earth (triggered by the carrier frequency). Remedies: Replace the RCD (residual current device) or lower the response limit.

Compensation systems

If the frequency inverter is operated on power supply networks with compensation systems, these systems must be designed by the manufacturer for operation in conjunction with a frequency inverter.

Information on electromagnetic compatibility

Electromagnetic interference from other electrical devices can affect the frequency inverter. Interference can also be emitted by the frequency inverter itself, however.

The interference emitted by the frequency inverter is generally conducted through the motor power cables. The following measures are proposed for RFI suppression:

- Shielded motor power cables for line lengths > 70 cm (especially recommended for frequency inverters with low power ratings)
- Made from a single piece of formed metal cable ducting with a minimum coverage of 80 % (if shielded connection cables cannot be used)

Use different earth bus bars for the control cable and mains power/motor power cables.

The shield on the power cable/connection cable must consist of a single piece and be earthed at both ends either just on the appropriate earth terminal or on the earth bus bar (do not connect it to the earth bus bar in the control cabinet).

The shielded cable ensures that the high-frequency current, which normally flows as a discharge current from the motor housing to earth or between the individual conductors, flows through the shielding.

The shield for the control cable (connection on the frequency inverter side only) also serves as protection against radiated emission.

If using shielded cables, use a wide contact face for the different earth connections to ensure greater interference immunity.

In applications with long shielded motor cables, provide additional reactive resistors or output filters to compensate the capacitive stray current to earth and reduce the rate of voltage rise on the motor. These measures help reduce radio interference further. Using just ferrite rings or reactive resistors does not ensure compliance with the limit values defined in the EMC directive.

NOTE! If you are using shielded cables that are longer than 10 m, check the stray capacitance to ensure that the diffusion between the phases or to earth is not excessive, which could cause the frequency inverter to stop.

Route control cable and mains power/motor power cables in separate cable ducts.

When routing the control cable observe a minimum distance of 0.3 metres between the control cable and the mains power/ motor power cables.

If you cannot avoid crossing control and mains power/motor power cables, you should cross them at 90 degrees to each other.

Earth connection

The frequency inverter must be properly earthed.

To ensure greater interference immunity, a wide contact face is required for the different earth connections.

In the case of cabinet mounting, use two separate copper earth bus bars (mains power connection / motor connection and control connection bar) with a suitable size and cross-section for earthing the frequency inverter. All the earth connections are connected to these.

The bars are connected to the earthing system at one point only.

The control cabinet is earthed via the mains earthing system.

Output filter



Fig. 6: Installing line choke and output filters

	Transformer		Dv/dt output filters (suitable for asynchronous motor and KSB SuPremE motor)
			or
			Sine filter (only suitable for asynchronous motor)
	Line choke		Motor

The maximum cable lengths must be observed in order to meet RFI suppression requirements to DIN 55011. Output filters are required if the maximum cable lengths are exceeded.

IGBT switchgear is suitable for achieving high power. This, however, can result in faults due to the rapid switching operations, particularly if you are using long motor cables / drive control cables:

- Electromagnetic interference
- Damage to the motor winding insulation
- Voltage peaks due to high stray capacitance on the cable connections
- Damage to the short-circuit protective devices

Output filters can be used to remedy these situations:

When a filter is used, the voltage peak (V_{peak}) and its rate of rise (dv/dt) can be reduced. The peak voltages can also be seen as a function of the stray capacitance induced by the power circuits. The stray capacitance must be below 5 nF. If long cables are required for installation reasons, for example, for wall or control cabinet mounting, and the stray capacitance value exceeds the maximum permissible value, a dv/dt limiting filter or sine filter must be installed. Connect the filter at the output of the frequency inverter. The filter protects the frequency inverter against excessive discharge currents and prevents the protective equipment from being deactivated as a result.

Overview of output filters for PumpDrive 2

Output filters for motor power cables 50 m / 80 m

Frequency inverter power	Nominal output current Frequency inverter	Output filter											
		Nominal current at 50 °C	Nominal current at 40 °C	dv/dt filter for			Maximum motor frequency	Maximum motor power cable length	L	B	H	Mat. No.	
				Asynchronous motors	KSB SuPremE								
[kW]	[A]	[A]	[A]	1500 rpm	3000 rpm	[Hz]	[m]	[mm]	[mm]	[mm]		[kg]	
0,37	1,3	6,1	-	FOVT-008B			140	50	49	85	58	47121240	1,6
0,55	1,8												
0,75	2,5												
1,1	3,5												
1,5	4,9												
2,2	6												
3	8	12,1	-	FOVT-016B			140	50	150	100	56	47121247	2,2
4	10												
5,5	14	18,9	-	FOVT-025B			140	50	231	119	71	47121248	4,5
7,5	18												
11	25	27,3	-	FOVT-036B			140	50	350	149	81	47121249	5,8
15	34,5												
		66	-	FOVT-036B	FOVT-036B	-	70	50	350	149	81	47121249	5,8
				-	-	FN510-66-34	200	50	470	235	140	47121253	22
18,5	44	50	-	FN-510-50-34	FN-510-50-34	-	200	50	470	235	140	47121251	21
22	51	66	-	FN-510-66-34	FN-510-66-34	-	200	50	470	235	140	47121253	22
30	68	-	90	RWK-305-90-KL	RWK-305-90-KL	-	60	80	190	115	225	47121254	7,4
37	85,9												
45	101	-	124	RWK-305-124-KS	RWK-305-124-KS	-	60	80	190	180	160	01665521	7,57
55	120	-	156	RWK 305-156-KS	RWK 305-156-KS	-	60	80	190	180	160	01665522	9,5

Output filters for motor power cables up to 160 m

Frequency inverter power	Nominal output current Frequency inverter	Output filter											
		Nominal current at 45 °C ²⁷⁾	Asynchronous motors	dv/dt filter for			Maximum motor frequency	Maximum motor power cable length	L	B	H	Mat. No.	
				KSB SuPremE									
[kW]	[A]	[A]		1500 rpm	3000 rpm	[Hz]	[m]	[mm]	[mm]	[mm]		[kg]	
0,37	1,3	8,4		FN 5060-12-84			≤140	160	125	85,5	104	01686772	1
0,55	1,8												
0,75	2,5												
1,1	3,5												

²⁷ Including derating

Frequency inverter power	Nominal output current Frequency inverter	Output filter											
		Nominal current at 45 °C ⁽²⁷⁾	dv/dt filter for				Maximum motor frequency	Maximum motor power cable length	L	B	H	Mat. No.	
			Asynchronous motors	KSB SuPremE									
[kW]	[A]	[A]	1500 rpm	3000 rpm	[Hz]	[m]	[mm]	[mm]	[mm]			[kg]	
1,5	4,9	8,4	FN 5060-12-84			≤140	160	125	85,5	104	01686772	1	
2,2	6												
3	8												
4	10	16,8	FN 5060-24-84			≤140	160	140	96	113	01686773	1,6	
5,5	14												
7,5	18	21	FN 5060-30-99			≤140	160	240	109	151	01686774	5,85	
11	25	31,5	FN 5060-45-99			≤140	160	240	110	151	01686775	6,4	
15	34,5	43,2	FN 5060-45-99	FN 5060-45-99	-	≤70	160	240	110	151	01686775	6,4	
		42	-	-	FN 5060-60-99	≤140	160	240	110	181	01686776	7	
18,5	44	57,6	FN 5060-60-99	-	-	≤70	160	240	110	181	01686776	7	
		49	-	-	FN 5060-70-99	≤140	160	240	121	222	01686857	8,52	
22	51	57,6	FN 5060-60-99	-	-	≤70	160	240	110	181	01686776	7	
		63	-	-	FN 5060-90-99	≤140	160	240	130	221	01686858	10,5	
30	68	63	-	-	FN 5060-90-99	≤70	160	240	130	221	01686858	10,5	
		77	-	-	FN 5060-110-99	≤140	160	240	136	221	01686859	11,35	
37	85,9	86,4	-	-	FN 5060-90-99	≤70	160	240	130	221	01686858	10,5	
		105	-	-	FN 5060-150-99	≤140	160	240	141,5	254	01686860	14,47	
45	101	105,6	-	-	FN 5060-110-99	≤70	160	240	136	221	01686859	11,35	
		105	-	-	FN 5060-150-99	≤140	160	240	141,5	254	01686860	14,47	
55	120	144	-	-	FN 5060-150-99	≤70	160	240	141,5	254	01686860	14,47	
		126	-	-	FN 5060-180-99	≤140	160	240	142,5	310	01686861	17,3	

Line chokes

The line input currents indicated in the selection information are for orientation purposes only; they refer to operation at nominal rating. These currents may vary depending on the actual line impedance. In low-impedance mains, higher currents may occur. The input current can be limited by using external line chokes in addition to the integrated line chokes (in the power range up to and including 45 kW). Line chokes reduce mains feedback and improve the power factor.

Line chokes connected in series in the line to the consumer installation ensure that the required short circuit voltage of 4 % to the mains is complied with and reduce mains feedback. Mains feedback occurring in the form of harmonics may cause problems in the public power supply mains. The charge currents of the DC link capacitors can be limited, which will increase the service life of these primary components. Line chokes reduce the reactive power component and thus improve the effective power factor. The scope of DIN EN 61000-3-2 must be heeded.

Three-phase line choke:

- Enclosure IP00
- Thermal class F
- Maximum ambient temperature 40 °C

Overview of line chokes for asynchronous motors and SuPremE motors



Size	Rating	Line choke inductance I_n	Nominal current $I_{Nominal\ motor\ current}$	Maximum current $I_{I_{sat}}$	L	W	H	Mat. No.		
									[kW]	[mH]
A	..000K37..	0,37	7,0	6,0	1,5 I_n	150	85	155	01665518	3,6
	..000K55..	0,55								
	..000K75..	0,75								
	..001K10..	1,1								
	..001K50..	1,5								
B	..002K20..	2,2	2,0	11	1,5 I_n	150	85	150	01093105	3,6
	..003K00..	3								
	..004K00..	4								
C	..005K50..	5,5	1,1	28	1,5 I_n	180	120	178	01093106	8,3

Size	Rating	Line choke inductance	Nominal current	Maximum current	L	W	H	Mat. No.		
		I_n	Nominal motor current	I_{sat}	[mm]	[mm]	[mm]			[kg]
C	..007K50..	7,5	1,1	28	1,5 I_n	180	120	178	01093106	8,3
	..011K00..	11								
D	..015K00..	15	0,5	51	1,5 I_n	180	135	178	01093107	9,17
	..018K50..	18,5								
	..022K00..	22	0,1	100	1,5 I_n	180	180	180	01093108	9,17
	..030K00..	30								
E	..037K00..	37	0,1	125	1,5 I_n	240	145	190	01665519	14
	..045K00..	45								
	..055K00..	55								

Accessories



Service software (PumpDrive 2 / PumpDrive 2 Eco)

Accessories: Service software (PumpDrive 2/PumpDrive 2 Eco)

	Description	Design	Mat. No.	[kg]
	USB parameterisation cable, optical For frequency inverter parameterisation with Automation service software Pre-configured with optical connection for frequency inverter and USB connection for laptop/ PC	Length 1 m	01538436	0,2
	Service dongle For authorisation The service software can also be used without a dongle. However, the parameters used for customer service will be locked in this case. The dongle can only be used after it has been enabled by KSB in accordance with the instructions included.	-	47121256	0,1

Control panels (PumpDrive 2)

Accessories: PumpDrive 2 control panels

	Description	Design	Mat. No.	[kg]
	Wall mounting brackets accessories set For mounting the graphical control panel of the frequency inverter 4 brackets and screws	Wall mounting/ mounting on a pipe	01522974	0,3
	Connection cable for graphical control panel For connecting the graphical control panel separately from the frequency inverter Colour: black, straight connector, angled socket	Length 3 m	01522975	0,3
		Length 5 m	01566211	0,3
		Length 10 m	01566212	0,6
		Length 20 m	01566213	1

Motor mounting adapter (PumpDrive 2 / PumpDrive 2 Eco)

An adapter is required to mount the frequency inverter to the motor. Select the adapter based on the motor size and the type of construction used.

KSB SuPremE type A (sizes 180 to 225): No motor mounting adapters can be retrofitted for PumpDrive 2 and PumpDrive 2 Eco. The preferred mounting option is wall mounting.



KSB SuPremE type B1 (size 180 to 225): Adapters for PumpDrive 2/ PumpDrive 2 Eco for motor mounting upon the customer's request or if a replacement is needed (replacement of PumpDrive 1 with PumpDrive 2) can be retrofitted.

KSB SuPremE type B2: Use for new installations with PumpDrive 2 and PumpDrive 2 Eco.



Accessories: Motor mounting adapter (PumpDrive 2 / PumpDrive 2 Eco)

	Description	Design		Mat. No.	[kg]		
		Frequency inverter size	P [kW]			Motor	
	Motor adapter kit For mounting frequency inverter to KSB motor/ Siemens standardised motor, type 1LE1/ 1PC3, 2-pole/ 4-pole/ 6-pole, IE2/ IE3 With power cable	A	0,37 - 1,5	BG80	01496568	3	
		A	0,37 - 1,5	BG90	01496569	3	
		B	2,2 - 4	BG90	01496570	3	
		B	2,2 - 4	BG100	01496571	3	
		B	2,2 - 4	BG112	01496572	3,8	
		C	5,5 - 11	BG132	01496573	3,8	
		C	5,5 - 11	BG160	01496574	3,8	
		D	15 - 30	BG160	01496575	5,2	
		D	18,5/22	BG180 M, L	01496576	8	
		D	30	BG200 L	01496577	10	
		D	15 - 30	BG225	01654738	11	
		E	37	BG200 L	01496578	14,2	
		E	37/45	BG225 S, M	01496579	11	
		E	37 - 55	BG250 M	01496580	14	
		E	37 - 55	BG280 S, M	01500521	16	
-	Motor adapter kit For mounting frequency inverter to KSB motor/ Siemens standardised motor, type 1LA7/ 1LA9/ 1LG6 (retrofit), 2-pole/ 4-pole With power cable	A	0,37 - 1,5	1LA7 BG71M V1	01506318	3	
		A	0,37 - 1,5	1LA9 BG80 V1	01506320	3	
		A	0,37 - 1,5	1LA7 BG80 V1	01506320	3	
		A	0,37 - 1,5	1LA9 BG90 V1	01506322	3	
		A	0,37 - 1,5	1LA9 BG90 B3	01606776	3	
		B	2,2 - 4	1LA9 BG90 B3	01506323	3	
		B	2,2 - 4	1LA9 BG90 V1	01606892	3	
		B	2,2 - 4	1LA9 BG100 B3	01506324	3	
		B	2,2 - 4	1LA9 BG100 V15	01606893	3	
		B	2,2 - 4	1LA7 BG112 B3/V15 1LA9 BG112 B3/V15	01506325	3,8	
		C	5,5 - 11	1LA9 BG132 B3/V15	01506326	3,8	
		C	5,5 - 11	1LA9 BG160 B3/V15	01506328	3,8	
		D	15 - 30	1LA9 BG160 B3/V15	01506329	5,2	
		D	15 - 30	1LA9 BG180 B3/V15	01506331	8	
		D	15 - 30	1LA9 BG200 B3/V15	01506332	10	
E	37 - 55	1LA9 BG200 B3	01506333	10			
E	37 - 55	1LG6 BG225S B3	01506334	11			
E	37 - 55	1LG6 BG225M B3	01650429	11			
	Motor adapter kit For mounting frequency inverter to KSB SuPremE A/ SuPremE B1 motor, 2-pole/ 4-pole With power cable	A	0,55/0,75/1,1	BG80 M	01666670	3	
		A	1,1/1,5	BG90 S	01666671	3,5	
		A	1,5	BG90 L	01677488	3,7	
		B	2,2	BG90 L	01666672	3,7	
		B	2,2/3	BG100 L	01666673	4	
		B	4	BG112 M	01666674	4,1	
		C	5,5/7,5	BG132 S, M	01666675	4,2	
		C	11	BG160 M	01666677	3,8	
		D	15	BG160 M	01675995	3,8	
		D	15/18,5	BG160 L	01677489	5,2	
		Motor adapter kit For mounting frequency inverter to KSB SuPremE B1 motor, 2-pole/ 4-pole With power cable	D	18,5/22	BG180 M, L	01496576	8
			D	30	BG200 L	01496577	10
			E	37	BG200 L	01496578	14,2
			E	37/45	BG225 S, M	01496579	11

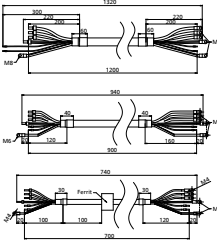
Accessories: Power/connection cable (PumpDrive 2)

	Description	Design	Mat. No.	[kg]
	Cable connector, shielded	≤ 4 kW: 4 × 2,5 ² + PTC...XM	01538433	0,9
	Blanking plate including screws to replace removed motor connector	-	01595759	0,1
	Motor power cable, shielded For connecting the PTC sensor, halogen-free, price per unit	≤ 4 kW: 4 × 2,5 mm ² + PTC Length 0.7 m	47117500	0,3
		5,5 - 7,5 kW: 4 × 4 mm ² + PTC Length 0.9 m	01437169	0,3
		11 kW: 4 × 6 mm ² + PTC Length 0.9 m	01637009	0,3
		15 kW: 4 × 10 mm ² + PTC Length 0.9 m	47117506	0,8
		18,5 - 22 kW: 4 × 16 mm ² + PTC Length 1.15 m	01466746	1
		30 kW: 4 × 25 mm ² + PTC Length 1.2 m	47117509	1,7
		37 kW: 4 × 35 mm ² + PTC Length 1.4 m	01641614	2
		45 kW: 4 × 50 mm ² + PTC Length 1.5 m	01641615	2,4
	55 kW: 4 × 70 mm ² + PTC Length 1.6 m	01641616	3,3	

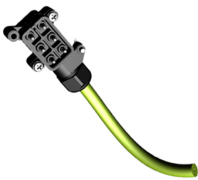
Accessories: Power cable (PumpDrive 2 Eco)

	Description	Design	Mat. No.	[kg]
	Cable connector, shielded	≤ 4 kW: 4 × 2,5 ² + PTC...XM	01538433	0,9
	Ferrite core, motor power cable	-	47117922	0,3
	Blanking plate including screws to replace removed motor connector	-	01595759	0,1

	Description	Design	Mat. No.	[kg]
	Motor power cable, shielded	≤ 4 kW: 4 x 2,5 mm ² + PTC Length 0.7 m	47117500	0,3
	For connecting the PTC sensor, halogen-free, price per unit	5,5 - 7,5 kW: 4 x 4 mm ² + PTC Length 0.9 m	01437169	0,3
		11 kW: 4 x 6 mm ² + PTC Length 0.9 m	01637009	0,3

Wall mounting adapter /cabinet mounting adapter (PumpDrive 2 / PumpDrive 2 Eco)

An adapter is required for the wall / cabinet-mounted frequency inverter. An adapter is included in the KSB scope of supply as standard.

Accessories: Wall/ cabinet mounting adapters (PumpDrive 2/ PumpDrive 2 Eco)

	Description	Mat. No.	[kg]
	Adapter kit, frequency inverter, size A	01496581	0,2
	Adapter kit, frequency inverter, size B	01579783	0,3
	Adapter kit, frequency inverter, size C	01496582	0,5
	Adapter kit, frequency inverter, size D	01629744	3
	Adapter kit, frequency inverter, size E	01629745	10
	Adapter kit, frequency inverter, size E with larger distance from the wall	01671121	10

M12 module (PumpDrive 2 / PumpDrive 2 Eco)

Accessories: M12 module (PumpDrive 2/ PumpDrive 2 Eco)

	Description	Design	Mat. No.	[kg]
	M12 module accessory kit For multiple pump configuration with up to 6 pumps For connecting PumpMeter via Modbus	-	01496566	0,3
	Blind cover For closing an open slot	-	01496567	0,1
	M12 protective cap for M12 module	-	01125084	0,05
	Bus cable, pre-configured, shielded For dual pump / multiple pump configuration For looping the KSB device bus (CAN) from frequency inverter to frequency inverter via the M12 module Colour: purple; M12 connector, angled; M12 connector, angled A-coded, 5 poles	Length 1 m	01533747	0,1
		Length 2 m	01533748	0,2
		Length 3 m	01533749	0,3
		Length 5 m	01651182	0,3
		Length 10 m	01651183	0,6
		Length 20 m	01651184	1,2
	Terminating resistors CAN for bus termination of multiple pump configuration Two M12 connectors with integrated CAN terminating resistor	-	01522993	0,3

	Description	Design	Mat. No.	[kg]
	PumpMeter cross-link bus cable, pre-configured, shielded For redundantly connecting PumpMeter via Modbus For looping the PumpMeter Modbus from frequency inverter to frequency inverter via the M12 module For analog sensors 4 - 20 mA Colour: black; M12 connector, angled; M12 connector, angled A-coded, 5 poles	Length 1 m	01533769	0,1
		Length 2 m	01533770	0,2
		Length 3 m	01533771	0,2
		Length 5 m	01533772	0,3
		Length 10 m	01533773	0,6
		Length 20 m	01533774	1,2
	M12 bus cable, PumpMeter, pre-configured, shielded For connecting PumpMeter to M12 module via Modbus Colour: black; M12 socket, straight; M12 connector, angled A-coded, 5 poles	Length 1 m	01533775	0,2
		Length 2 m	01533776	0,2
		Length 3 m	01533777	0,3
		Length 5 m	01533778	0,3
		Length 10 m	01670718	0,445
		Length 20 m	01670719	1,2
	M12 connector for M12 module, for self-assembly For multiple pump configuration For connecting PumpMeter via Modbus Not suitable for direct connection of a PumpMeter sensor (no vent pin 5) Angled connector, A-coded, 5-pole Screw terminal connection with shield ring, shieldable, Connection cross-section: Max. 0.75 mm ² (max. AWG 20) Cable passage: 4 - 6 / 5 - 8 / 6 - 8 / 6.5 - 8.5 [mm] Enclosure IP67	-	01523004	0,1







Optional components (PumpDrive 2 / PumpDrive 2 Eco)

Optional modules for retrofitting (PumpDrive 2)

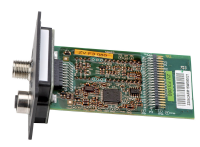
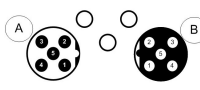

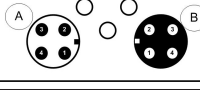
	Description	Design	Mat. No.	[kg]
	Master switch retrofit kit ²⁸⁾ Master switch, adapted C cover, protective cover for the master switch, wire harness Voltage 400 V	Size A 0,37 - 1,5 kW	01500522	1,4
		Size B 2,2 - 4 kW	01500523	1,7
		Size C 5,5 - 11 kW	01500524	2,8
		Size D 15 - 30 kW	01500525	5,5
		Size E 37 - 55 kW	01500526	14,5
	I/O extension board Additional inputs and outputs: 1 analog input, 1 analog output, 3 digital inputs, 2 digital outputs, 1 changeover contact relay, 5 NO contact relays	Sizes A, B, C, D, E	01537900	0,2
	Modbus RTU field bus module For connecting the frequency inverter to Modbus networks Monitoring, open-loop control, closed-loop control of frequency inverter in single-pump configuration and multiple pump configuration with Modbus module only Field bus cable connection looped through from 1 x M12 connector, B-coded, 5-pole, to 1 x M12 socket, B-coded, 5-pole	Sizes A, B, C, D, E	01551016	0,3

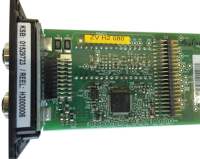
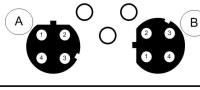
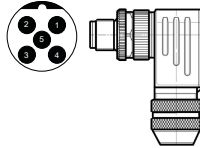
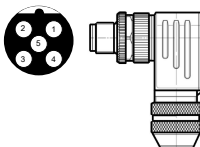
4074.5/06-EN

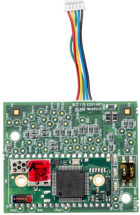

²⁸ Optional master switch up to 400 V AC +10 %

	Description	Design	Mat. No.	[kg]
 	BACnet MS/TP module field bus module For connecting the frequency inverter to BACnet network Monitoring, open-loop control, closed-loop control of frequency inverter in single-pump and multiple-pump configuration with BACnet module only	Sizes A, B, C, D, E	01551014	0,3
 	LON field bus module For connecting the frequency inverter to LON network Monitoring, open-loop control, closed-loop control of each frequency inverter in single-pump configuration and multiple pump configuration only with one LON module each Field bus cable connection looped through from 1 x M12 connector, A-coded, 4-pole, to 1 x M12 socket, A-coded, 4-pole	Sizes A, B, C, D, E	01551015	0,3
 	Profibus field bus module For connecting the frequency inverter to Profibus networks Monitoring, open-loop control, closed-loop control of each frequency inverter in single-pump configuration and multiple pump configuration only with one Profibus module each Field bus cable connection looped through from 1 x M12 connector, B-coded, 5-pole, to 1 x M12 socket, B-coded, 5-pole	Sizes A, B, C, D, E	01551037	0,3
 	Profinet module field bus module For connecting the frequency inverter to Profinet network Monitoring, open-loop control, closed-loop control of each frequency inverter in single-pump configuration and multiple pump configuration only with one Profinet module each	Sizes A, B, C, D, E	01551038	0,3
	M12 connector for self-assembly For Modbus , BACnet and Profibus Angled connector, B-coded, 5 poles, screw terminal connection, with shield ring, shieldable Connection cross-section: Max. 0.75 mm ² (max. AWG 20) Cable passage: 4 - 6 / 5 - 8 / 6 - 8 / 6.5 - 8.5 [mm] Enclosure: IP67	-	01651264	0,1
	M12 socket for self-assembly For Modbus , BACnet and Profibus Angled socket, B-coded, 5 poles, screw terminal connection, with shield ring, shieldable Connection cross-section: Max. 0.75 mm ² (max. AWG 20) Cable passage: 4 - 6 / 5 - 8 / 6 - 8 / 6.5 - 8.5 [mm] Enclosure: IP67	-	01651298	0,1
	Bus cable CAN, BACnet and Modbus Cut to length for self-assembly, shielded, twisted pair, cable 2 x 2 x 0.22 mm ²	Length 1 m Length 5 m Length 10 m Length 20 m	01111184 01304511 01304512 01304513	0,2 0,4 0,7 1,4

4074.5/06-EN

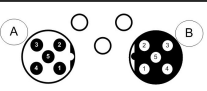
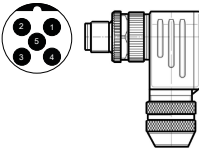
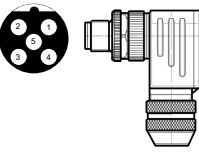

	Description	Design	Mat. No.	[kg]
	M12 terminating resistor for Profibus, Modbus and BACnet B-coded, connector The terminating resistor is designed to plug into the free M12 socket on the Profibus module / Modbus module.	-	01125102	0,1
	Bluetooth module, retrofittable For communication with a smartphone/tablet (Android or iOS) Installation in the control panel of the frequency inverter Bluetooth 2.0, range approx. 10 m, compatible from Apple iOS 8 and Android 8.0 Free download of KSB FlowManager app from the App Store and the Google Play Store	-	01496565	0,1
	External Bluetooth gateway for communication with a smartphone/tablet (Android or iOS) or notebook For plugging onto the service interface of the frequency inverter Bluetooth 2.0, range approx. 10 m, compatible from Apple iOS 8 and Android 8.0 Free download of KSB FlowManager app from the App Store and the Google Play Store	-	01800770	0,1
-	Set of cable sealing elements PDRV2 EMV A-B-C-D-E EMC cable gland kit for PumpDrive 2 For using PumpDrive 2 in electrical plants of the automotive industry in accordance with electromagnetic compatibility requirements, EMC-ILA	-	01711794	0,12

Installation modules for retrofitting (PumpDrive 2 Eco)

	Description	Design	Mat. No.	[kg]
 	Modbus RTU field bus module For connecting the frequency inverter to Modbus networks ²⁹⁾ Monitoring, open-loop control, closed-loop control of frequency inverter in single-pump configuration and multiple pump configuration with Modbus module only Field bus cable connection looped through from 1 x M12 connector, B-coded, 5-pole, to 1 x M12 socket, B-coded, 5-pole	Sizes A, B, C, D, E	01551016	0,3
	M12 connector for self-assembly For Modbus , BACnet and Profibus Angled connector, B-coded, 5 poles, screw terminal connection, with shield ring, shieldable Connection cross-section: Max. 0.75 mm ² (max. AWG 20) Cable passage: 4 - 6 / 5 - 8 / 6 - 8 / 6.5 - 8.5 [mm] Enclosure: IP67	-	01651264	0,1
	M12 socket for self-assembly For Modbus , BACnet and Profibus Angled socket, B-coded, 5 poles, screw terminal connection, with shield ring, shieldable Connection cross-section: Max. 0.75 mm ² (max. AWG 20) Cable passage: 4 - 6 / 5 - 8 / 6 - 8 / 6.5 - 8.5 [mm] Enclosure: IP67	-	01651298	0,1
	Bus cable CAN, BACnet and Modbus Cut to length for self-assembly, shielded, twisted pair, cable 2 x 2 x 0.22 mm ²	Length 1 m Length 5 m Length 10 m Length 20 m	01111184 01304511 01304512 01304513	0,2 0,4 0,7 1,4



4074.5/06-EN



²⁹⁾ PumpDrive 2 Eco has only got one slot into which either the M12 module or the Modbus RTU module can be inserted.

	Description	Design	Mat. No.	[kg]
	M12 terminating resistor for Profibus, Modbus and BACnet B-coded, connector The terminating resistor is designed to plug into the free M12 socket on the Profibus module / Modbus module.	-	01125102	0,1
	Bluetooth module, retrofittable For communication with a smartphone/tablet (Android or iOS) Installation in the control panel of the frequency inverter Bluetooth 2.0, range approx. 10 m, compatible from Apple iOS 8 and Android 8.0 Free download of KSB FlowManager app from the App Store and the Google Play Store	-	01496565	0,1
	External Bluetooth gateway for communication with a smartphone/tablet (Android or iOS) or notebook For plugging onto the service interface of the frequency inverter Bluetooth 2.0, range approx. 10 m, compatible from Apple iOS 8 and Android 8.0 Free download of KSB FlowManager app from the App Store and the Google Play Store	-	01800770	0,1
-	Cable sealing set PDRV2 ECO EMC A-B-C EMC cable gland kit for PumpDrive 2 ECO For using PumpDrive 2 ECO in electrical plants of the automotive industry in accordance with electromagnetic compatibility requirements, EMC-ILA	-	01711792	0,1

Sensors (PumpDrive 2 / PumpDrive 2 Eco)

Accessories: Pressure measurement (PumpDrive 2 / PumpDrive 2 Eco)

	Description	Design	Mat. No.	[kg]
	PumpMeter Intelligent pressure transmitter for pumps with on-site display of measured values and operating data, parameterised at the factory in line with pump-specific requirements, selection via KSB EasySelect	Pump-specific	-	0,1
	Differential pressure transducer With two copper-spiralled pipe sections measuring 75 cm in length for connection to the discharge nozzle / suction nozzle, complete with retaining plate, spiralled pipe section and adapter, output 4 - 20 mA, 3-wire power supply, supply voltage 18 - 30 V DC, 2.5 m connection cable Ambient temperature -10 to +50 °C Temperature of measured medium -10 to +80 °C	0 - 1 bar, RC3/8	01111180	0,3
		0 - 2 bar, RC3/8	01109558	0,3
		0 - 4 bar, RC3/8	01109560	0,3
		0 - 6 bar, RC3/8	01109562	0,3
		0 - 10 bar, RC3/8	01109585	0,3
		0 - 1 bar, RC1/2	01111303	0,3
		0 - 2 bar, RC1/2	01111305	0,3
		0 - 4 bar, RC1/2	01111306	0,3
		0 - 6 bar, RC1/2	01111307	0,3
		0 - 10 bar, RC1/2	01111308	0,3
		0 - 1 bar, RC 1/4	01558789	0,3
		0 - 2 bar, RC 1/4	01558790	0,3
0 - 4 bar, RC 1/4	01558791	0,3		
0 - 6 bar, RC 1/4	01558792	0,3		
0 - 10 bar, RC 1/4	01558793	0,3		
	A-10 pressure transducer For general applications, for liquid and gaseous fluids 0 to +80 °C, measuring accuracy smaller than or equal to 1 %, 2.5 % max. (at 80 °C), G1/4B process connection with Cu joint ring, IP67, 2-wire output 4 - 20 mA	0 - 2 bar	01152023	0,07
		0 - 5 bar	01152024	0,07
		0 - 10 bar	01210880	0,4
		0 - 16 bar	01073808	0,128
		0 - 20 bar	01152025	0,07
		0 - 50 bar	01152026	0,07

	Description	Design	Mat. No.	[kg]
	S-20 pressure transducer For general applications in industry, mechanical engineering, hydraulics, pneumatics, pneumatics, for liquid and gaseous fluids -30 to +100 °C, parts in contact with the measured medium made of CrNi steel (no gaskets), mechanical shock load capacity up to 100 g (IEC 60068-2-27), vibration load capacity at resonance up to 20 g (IEC 60068-2-6), measuring accuracy < 0.5 % of measuring range, G1/2B EN837 connection, IP65 enclosure, 2-wire output 4 - 20 mA, maximum line cross-section of 1.5 mm ² , outer line diameter of 6 to 8 mm, electrical connection via angular connector to DIN 175301-803 A	0 - 1.0 bar	01147224	0,12
		0 - 1.6 bar	01147225	0,12
		0 - 2.5 bar	01147226	0,12
		0 - 4.0 bar	01147267	0,12
		0 - 6.0 bar	01147268	0,12
		0 - 10.0 bar	01147269	0,12
		0 - 16.0 bar	01084305	0,159
		0 - 25.0 bar	01084306	0,2
		0 - 40.0 bar	01087244	0,2
		-1 - 1.5 bar	01150958	0,6
		-1 - 5.0 bar	01087507	0,2
		-1 - 15.0 bar	01084308	0,2
		-1 - 24.0 bar	01084309	0,2
			S-11 pressure transducer For applications in the hygiene, food and beverage industries, for liquid, gaseous, viscous and contaminated fluids, Temperature of measured medium -30 to 100 °C; on request with integrated cooling section for temperatures of the measured medium of up to +150 °C, parts in contact with the measured medium made from CrNi steel (no gaskets); on request: Hastelloy C4 (2.4610) variant available for aggressive media, mechanical shock load capacity up to 1000 g (IEC 60068-2-27), vibration load capacity at resonance up to 20 g (IEC 60068-2-6), measuring accuracy < 0.5 % of measuring range, G1/2B EN837 connection, flush diaphragm, NBR O-ring, IP65 enclosure, 2-wire output 4 - 20 mA, maximum line cross-section of 1.5 mm ² , outer line diameter of 6 to 8 mm, auxiliary energy supply, UB: 10 < UB ≤ 30 V DC (14 to 30 for output 0 - 10 V), electrical connection via angular connector to DIN 175301-803 A	0 - 1.0 bar
0 - 1.6 bar	01147271			0,24
0 - 2.5 bar	01147272			0,24
0 - 4.0 bar	01147273			0,24
0 - 6.0 bar	01147274			0,24
0 - 10.0 bar	01147275			0,24
0 - 16.0 bar	01084310			0,24
0 - 25.0 bar	01084311			0,24
0 - 40.0 bar	01087246			0,24
-1 - 1.5 bar	01087506			0,24
-1 - 5.0 bar	01084307	0,24		
	Weld-in socket for S-20 / S-11 pressure transducers G1/2B process connection, internal thread	-	01149296	0,2

Accessories: Temperature measurement (PumpDrive 2 / PumpDrive 2 Eco)

	Description	Mat. No.	[kg]
	Resistance thermometer Pre-configured for temperatures of the measured medium of 0 - 150 °C, TR10-C sensor well, T24.10 transmitter and TW35-4 thermowell for measured medium temperatures of -200 °C to 600 °C, sensor tolerance: Class B to DIN EN 60751, 2-wire output 4 - 20 mA, measuring range with Pt100 element 1 x 3-wire, supply voltage: 10 - 36 V DC, G1/2B process connection made from CrNi steel 1.4571, total length with stem: 255 mm, thermometer installation length: 110 mm, connecting head type BSZ, aluminium, IP65 enclosure	01149295	0,8

Accessories: Flow measurement (PumpDrive 2 / PumpDrive 2 Eco)

	Description	Mat. No.	[kg]
	<p>Flow sensor</p> <p>3 ... 300 cm/s for filter loss compensation control, cost-effective flow control, measuring range 3 - 300 cm/s, process connection with internal thread, output 4 - 20 mA, Effector 300 transmitter</p>	01150960	0,3
	<p>Plug connector with cable for Effector 300 transmitter</p> <p>Cable socket M12/angled/4-core/5 m/PUR, compatible with cable drag chains, free of halogen and silicone</p>	01473177	0,2

Accessories: Connection cable (PumpDrive 2 / PumpDrive 2 Eco)

	Description	Mat. No.	[kg]
	<p>Connection cable for sensors</p> <p>Cable 2 x 2 x 0.5 mm², shielded, for connecting sensors to frequency inverter, price per metre</p>	01083890	0,1
	<p>Connection cable for redundant sensor connection</p> <p>5-core cable, halogen-free, type Ölflex 110CH, length approx. 1 m, pre-configured, for forwarding a sensor signal to a second frequency inverter for redundant operation (e.g. DPM)</p>	01131430	0,3

Control cabinet mounting (PumpDrive 2 / PumpDrive 2 Eco)

Accessories: Potential separator (PumpDrive 2 / PumpDrive 2 Eco)

	Description	Design	Mat. No.	[kg]
	<p>Potential separator</p> <p>For volt-free signal transmission between the frequency inverter and external control systems.</p> <p>Differences in potential can damage analog and digital inputs.</p>	<p>Top hat rail mounting, external supply voltage 24 V DC, IP40 housing, IP20 terminals, 22.5 x 82 x 118.2 mm (W x H x D)</p>	01085905	1,2
		<p>Top hat rail mounting, external supply voltage 230 V AC, IP40 housing, IP20 terminals, 22.5 x 82 x 118.2 mm (W x H x D)</p>	01086963	1,2

Accessories: Mains filter³⁰⁾ (PumpDrive 2 / PumpDrive 2 Eco)

	Description	Design	Mat. No.	[kg]
	Line choke for frequency inverter for preventing mains feedback	0,37 - 1,5 kW	01665518	3,6
		2,2 - 4 kW	01093105	3,6
	IP00 enclosure Protection of frequency inverter from peak voltages	5,5 - 11 kW	01093106	8,3
		15 - 18,5 kW	01093107	9,17
		22 - 37 kW	01093108	9,17
		45 - 55 kW	01665519	14

Accessories: Output filter, 400 V / 3~ variant (PumpDrive 2 / PumpDrive 2 Eco)

	Description	P _N	Design	Asynchronous motor	KSB SuPremE		Mat. No.	[kg]
		Frequency inverter			1500	3000		
	Output filters dv/dt for motor power cables up to 160 m, IP00 enclosure	0,37 - 3,00	FN 5060-12-84	X	X	X	01686772	1
		4,00 - 5,50	FN 5060-24-84	X	X	X	01686773	1,6
	Line chokes for reducing electromagnetic interference emissions Reduction of peak currents in long motor power cables	7,50	FN 5060-30-99	X	X	X	01686774	5,85
		11,00	FN 5060-45-99	X	X	X	01686775	6,4
		15,00	FN 5060-45-99	X	X	-	01686775	6,4
		15,00	FN 5060-60-99	-	-	X	01686776	7
		18,50	FN 5060-60-99	X	X	-	01686776	7
		18,50	FN 5060-70-99	-	-	X	01686857	8,52
		22,00	FN 5060-60-99	X	X	-	01686776	7
		22,00	FN 5060-90-99	-	-	X	01686858	10,5
		30,00	FN 5060-90-99	X	X	-	01686858	10,5
		30,00	FN 5060-110-99	-	-	X	01686859	11,35
		37,00	FN 5060-90-99	X	X	-	01686858	10,5
		37,00	FN 5060-150-99	-	-	X	01686860	14,47
		45,00	FN 5060-110-99	X	X	-	01686859	11,35
		45,00	FN 5060-150-99	-	-	X	01686860	14,47
55,00	FN 5060-150-99	X	-	-	01686860	14,47		

³⁰⁾ When using the 230 V / 1~ variant, mains filters are not necessary. This variant has an integrated PFC module.

Accessories: Output filter, 230 V / 1~ variant (PumpDrive 2 Eco)

	Description	P _N	Design	Asynchronous motor	KSB SuPremE		Mat. No.	[kg]
		Frequency inverter			1500	3000		
		[kW]			[rpm]			
	<p>Output filters dv/dt for motor power cables up to 160 m, IP00 enclosure</p> <p>Line chokes for reducing electromagnetic interference emissions</p> <p>Reduction of peak currents in long motor power cables</p>	0,5 - 1,1	FN 5060-12-84	x	-	-	01686772	1

PumpMeter

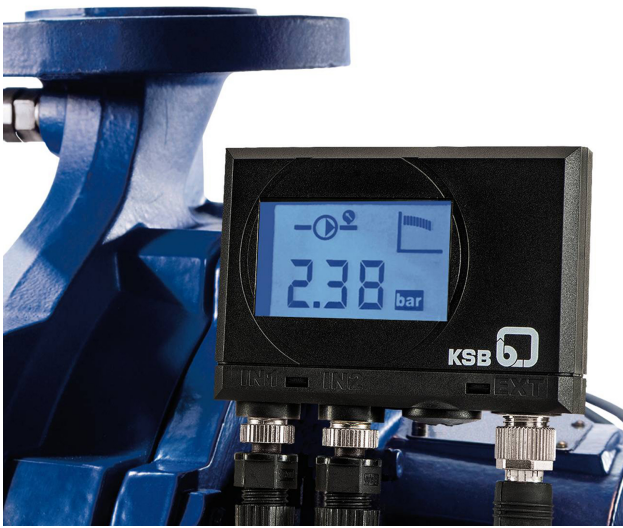

It records the load profile of the pump in order to indicate any potential for optimising energy efficiency and availability. The device comprises two pressure sensors and a display unit.

PumpMeter is supplied completely assembled and parameterised for the pump it is used with. It is ready for operation as soon as the M12 plug connector is plugged in.

Main applications

Industry:

- Air-conditioning systems
- Cooling circuits
- Heating systems
- Water treatment
- Cooling lubricant distribution
- Water extraction
- Service water supply

Water:

- Water supply systems
- Water treatment / water conditioning
- Water distribution / water transport

Building services:

- Air-conditioning systems
- Heating systems
- Water supply systems

General description

The PumpMeter device is designed for monitoring pump operation. It is an intelligent pressure transmitter for pumps, with on-site display of measured values and operating data.

Technical data

Technical data of the display unit

Characteristic	Value
Power supply	+24 V DC ±15 %
Current input	150 mA
Analog signal output	4 - 20 mA, 3-wire
Digital connection	RS485, Modbus RTU (Slave)
Enclosure	IP65 ³¹⁾
Service interface	RS232
Storage temperature	-30 °C to +80 °C
Operating temperature	-10 °C to +60 °C

Technical data of the sensors

Characteristic	Value
Signal	4 - 20 mA
Enclosure	IP67 ³²⁾
Fluid temperature	-30 °C to +140 °C
Fluid temperature (with insulated sensors)	-30 °C to +80 °C
Installation torque	10 Nm
Ambient temperature	-10 °C to +60 °C

Sensor pressure limits

Sensor measuring range		Overpressure limit	Burst pressure
Min.	Max.		
[bar]	[bar]	[bar]	[bar]
-1	3	40	60
-1	10	40	60
-1	16	40	60
-1	25	50	75

³¹ Provided that the connectors are connected correctly

³² Provided that the connectors are connected correctly

Sensor measuring range		Overpressure limit	Burst pressure
Min.	Max.		
[bar]	[bar]	[bar]	[bar]
-1	40	80	120
-1	65	130	195
-1	80	160	240

Materials

Overview of materials

Wetted components	Material
Pressure sensor measuring unit	1.4542
Pressure sensor measuring unit	Titanium ³³⁾
Pressure sensor process connection	1.4301
Pressure sensor process connection	Titanium ³³⁾
Adapter for fitting a sensor ³⁴⁾	1.0037 or 1.4571
Joint ring	Centellen

Product benefits

- Transparent pump operation by on-site display of all relevant operating data, e.g. the operating point of the pump
- Identifies potential energy savings by recording and analysing the load profile and displaying the energy efficiency icon (EFF) if applicable.
- Saves time and money as the sensors are fitted to the pump at the factory, unlike conventional instruments used in systems.
- Higher availability of the pump through detection and prevention of non-intended use

Functions

Pressure transmitter function

The discharge pressure or differential pressure of the pump are transmitted as a 4-20 mA signal. Connection via the RS485 serial interface with Modbus protocol is also possible.

Operating data display

The device alternately displays the suction pressure and discharge pressure as well as the differential pressure or head.

Recording and analysing of the load profile



The operating hours of the pump in the different modes of operation are recorded in a load profile and saved in a non-volatile memory (protected against power failure). The energy efficiency symbol is displayed when a potential for optimisation is recognised.

Qualitative indication of the pump's current operating point

The flashing segment indicates the position of the current operating point on the generalised characteristic curve.

³³ Special design for seawater applications

³⁴ Depending on the basic material variant of the pump

Qualitative indication of the pump's current operating point

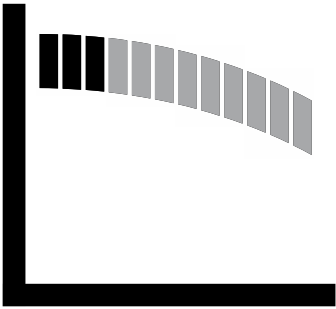
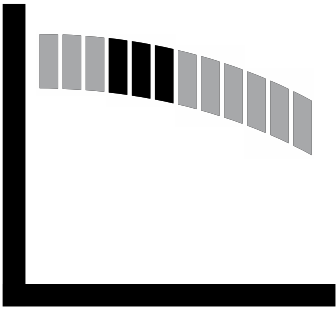
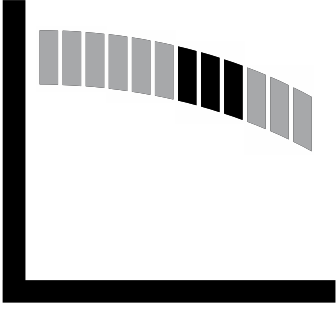
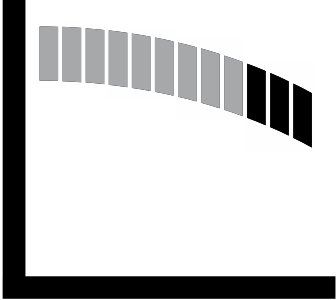
Operating range	Segment display	Description
Operation in extreme part load conditions ³⁵⁾ 	First quarter flashing (1)	<ul style="list-style-type: none"> Pump possibly not operated in accordance with its intended use Increased load on the components
Operation in moderate part load conditions ³⁵⁾ 	Second quarter flashing (2)	<ul style="list-style-type: none"> Operation with potential for optimising energy efficiency
Operation near BEP 	Third quarter flashing (3)	<ul style="list-style-type: none"> Operation within intended operating range. Optimum energy efficiency
Operation in overload conditions 	Fourth quarter flashing (4)	<ul style="list-style-type: none"> Limit of the intended operating range Possibly overload of pump and/or motor

4074.5/06-EN

³⁵⁾ For some pump characteristics, no differentiation is made between the part load operating conditions in the curve's first two quarters (both flashing simultaneously).

Design variants

- **Adapter:**
Depending on thread type and size of the pump's pressure gauge connections
- **Cable length:**
600 mm, 1200 mm or 1800 mm, depending on the pump size
- **Measuring ranges of the pressure sensors:**
The measuring ranges are selected as a function of the maximum pump inlet pressure specified (suction-side sensor) and the maximum pump discharge pressure at zero flow (discharge-side sensor). If no maximum inlet pressure is specified, calculation is based on a maximum inlet pressure of 5 bar.

Available measuring ranges

Label colour of sensor	Colour code	Measuring range [bar]	
		Minimum	Maximum
-	Red	-1	3
-	Blue	-1	10
-	Light grey	-1	16
-	Green	-1	25
-	Black	-1	40
Silver	None	-1	65
Yellow	None	-1	80

Electrical connections

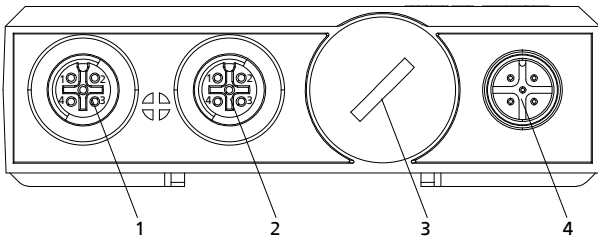

Fig. 7: Connections at the device

1	IN1 / port for the suction-side pressure sensor
2	IN2 / port for the discharge-side pressure sensor
3	Service interface
4	EXT / external port for energy supply and signal output

PumpMeter

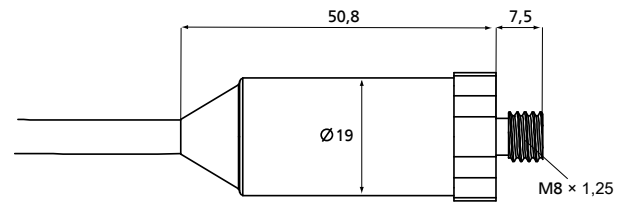

Fig. 8: Dimensions of sensor, measuring range up to 40 bar

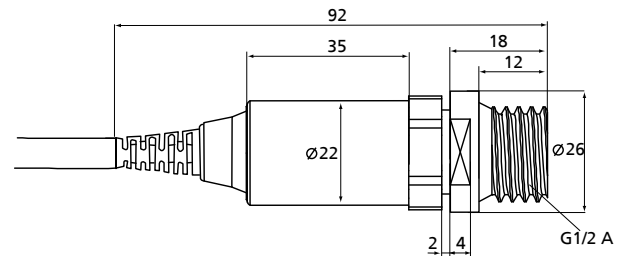

Fig. 9: Dimensions of sensor, measuring range 65 bar and above

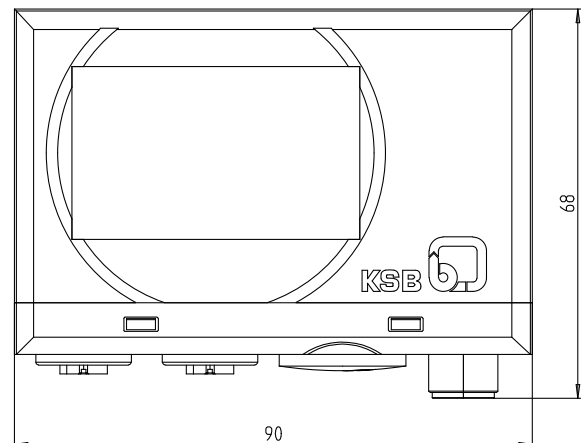
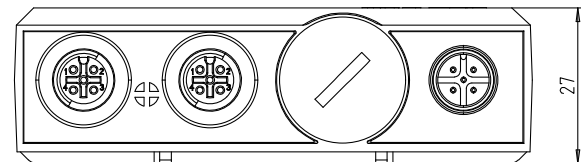

Fig. 10: Dimensions of the display unit



KSB SE & Co. KGaA
Johann-Klein-Straße 9 • 67227 Frankenthal (Germany)
Tel. +49 6233 86-0
www.ksb.com