

High-efficiency Circulator Pump

## Calio S

### Installation/Operating Manual



## **Legal information/Copyright**

Installation/Operating Manual Calio S

Original operating manual

All rights reserved. The contents provided herein must neither be distributed, copied, reproduced, edited or processed for any other purpose, nor otherwise transmitted, published or made available to a third party without the manufacturer's express written consent.

Subject to technical modification without prior notice.

© KSB SE & Co. KGaA, Frankenthal 03/04/2020

## Contents

	<b>Glossary .....</b>	<b>5</b>
<b>1</b>	<b>General.....</b>	<b>6</b>
	1.1 Principles .....	6
	1.2 Target group.....	6
	1.3 Other applicable documents.....	6
	1.4 Symbols .....	6
	1.5 Key to safety symbols/markings.....	7
<b>2</b>	<b>Safety .....</b>	<b>8</b>
	2.1 General.....	8
	2.2 Intended use .....	8
	2.2.1 Prevention of foreseeable misuse .....	8
	2.3 Personnel qualification and training.....	9
	2.4 Consequences and risks caused by non-compliance with this manual .....	9
	2.5 Safety awareness .....	9
	2.6 Safety information for the user/operator .....	9
	2.7 Safety information for maintenance, inspection and installation .....	10
	2.8 Unauthorised modes of operation .....	10
<b>3</b>	<b>Transport/Storage/Disposal .....</b>	<b>11</b>
	3.1 Checking the condition upon delivery .....	11
	3.2 Transport.....	11
	3.3 Storage/preservation .....	11
	3.4 Return to supplier.....	12
	3.5 Disposal .....	12
<b>4</b>	<b>Description.....</b>	<b>13</b>
	4.1 General description .....	13
	4.2 Product information as per Regulation No. 1907/2006 (REACH).....	13
	4.3 Designation.....	13
	4.4 Name plate.....	13
	4.5 Design details.....	14
	4.6 Configuration and function.....	15
	4.7 Noise characteristics .....	16
	4.8 Scope of supply.....	16
	4.9 Dimensions and weight.....	16
	4.10 Accessories .....	16
<b>5</b>	<b>Installation at Site .....</b>	<b>17</b>
	5.1 Safety regulations.....	17
	5.2 Checks to be carried out prior to installation.....	17
	5.3 Installing the pump set .....	17
	5.4 Connecting the piping .....	19
	5.5 Enclosure/insulation .....	20
	5.6 Electrical connection .....	20
	5.6.1 Connecting the power cable .....	21
<b>6</b>	<b>Commissioning/Start-up/Shutdown.....</b>	<b>23</b>
	6.1 Commissioning/Start-up .....	23
	6.1.1 Prerequisites for commissioning/start-up .....	23
	6.1.2 Priming and venting the pump.....	23
	6.1.3 Start-up.....	24
	6.2 Operating limits.....	25
	6.2.1 Frequency of starts.....	25
	6.2.2 Ambient temperature.....	25
	6.2.3 Minimum inlet pressure.....	25

---

6.2.4	Maximum operating pressure .....	26
6.2.5	Fluid handled .....	26
6.3	Shutdown.....	27
6.3.1	Shutdown .....	27
6.3.2	Measures to be taken for shutdown .....	27
6.4	Returning to service .....	28
<b>7</b>	<b>Operation.....</b>	<b>29</b>
7.1	Control panel .....	29
7.1.1	Display .....	29
7.2	Operating modes.....	30
7.2.1	Information on settings.....	30
7.2.2	Constant-pressure control .....	31
7.2.3	Proportional-pressure control .....	32
7.2.4	Open-loop control .....	34
7.3	Functions.....	35
7.3.1	Dynamic control.....	35
7.3.2	Setback operation.....	36
7.3.3	Protective functions.....	38
7.3.4	Saving data.....	38
7.3.5	Fault messages .....	38
<b>8</b>	<b>Servicing/Maintenance .....</b>	<b>39</b>
8.1	Servicing/maintenance/inspection .....	39
8.2	Drainage/cleaning .....	40
8.3	Removing the pump set from the piping .....	40
8.3.1	Removing the power cable .....	41
<b>9</b>	<b>Trouble-shooting.....</b>	<b>42</b>
<b>10</b>	<b>Related Documents .....</b>	<b>43</b>
10.1	Sectional drawing with list of components .....	43
<b>11</b>	<b>EU Declaration of Conformity .....</b>	<b>44</b>
	<b>Index .....</b>	<b>45</b>

## Glossary

### **Discharge line**

The pipeline which is connected to the discharge nozzle

### **Pump**

Machine without drive, additional components or accessories

### **Pump set**

Complete pump set consisting of pump, drive, additional components and accessories

### **Setback operation**

Setback Operation avoids running the pump set at an unchanged control curve during the night. It lowers the mass flow rate, noise level and power consumption.

### **Suction lift line/suction head line**

The pipeline which is connected to the suction nozzle

## 1 General

### 1.1 Principles

This operating manual is valid for the type series and variants indicated on the front cover.

The operating manual describes the proper and safe use of this equipment in all phases of operation.

The name plate indicates the type series and size as well as the main operating data. They uniquely identify the pump (set) and serve as identification for all further business processes.

In the event of damage, immediately contact your nearest KSB service facility to maintain the right to claim under warranty.

### 1.2 Target group

This operating manual is aimed at the target group of trained and qualified specialist technical personnel. (⇒ Section 2.3, Page 9)

### 1.3 Other applicable documents

**Table 1:** Overview of other applicable documents

Document	Contents
Data sheet	Description of the technical data of the pump (set)

For accessories and/or integrated machinery components observe the relevant manufacturer's product literature.









### 1.4 Symbols

**Table 2:** Symbols used in this manual

Symbol	Description
✓	Conditions which need to be fulfilled before proceeding with the step-by-step instructions
▷	Safety instructions
⇒	Result of an action
⇔	Cross-references
1. 2.	Step-by-step instructions
	Note Recommendations and important information on how to handle the product

### 1.5 Key to safety symbols/markings

Table 3: Definition of safety symbols/markings

Symbol	Description
	<b>DANGER</b> This signal word indicates a high-risk hazard which, if not avoided, will result in death or serious injury.
	<b>WARNING</b> This signal word indicates a medium-risk hazard which, if not avoided, could result in death or serious injury.
	<b>CAUTION</b> This signal word indicates a hazard which, if not avoided, could result in damage to the machine and its functions.
	<b>General hazard</b> In conjunction with one of the signal words this symbol indicates a hazard which will or could result in death or serious injury.
	<b>Electrical hazard</b> In conjunction with one of the signal words this symbol indicates a hazard involving electrical voltage and identifies information about protection against electrical voltage.
	<b>Machine damage</b> In conjunction with the signal word CAUTION this symbol indicates a hazard for the machine and its functions.
	<b>Warning: Strong magnetic field</b> In conjunction with one of the signal words this symbol indicates a hazard involving magnetic fields and identifies information about protection against magnetic fields.
	<b>Warning for persons with pacemaker</b> In conjunction with one of the signal words this symbol indicates a hazard involving magnetic fields and identifies special information for persons with a pacemaker.
	<b>Warning about hot surfaces</b> In conjunction with one of the signal words this symbol indicates a hazard involving hot surfaces.



## 2 Safety

All the information contained in this section refers to hazardous situations.

In addition to the present general safety information the action-related safety information given in the other sections must be observed.

### 2.1 General

- This operating manual contains general installation, operating and maintenance instructions that must be observed to ensure safe operation of the system and prevent personal injury and damage to property.
- Comply with all the safety instructions given in the individual sections of this operating manual.
- The operating manual must be read and understood by the responsible specialist personnel/operators prior to installation and commissioning.
- The contents of this operating manual must be available to the specialist personnel at the site at all times.
- Information and markings attached directly to the product must always be complied with and kept in a perfectly legible condition at all times. This applies to, for example:
  - Flow direction arrow
  - Markings for connections
  - Name plate
- The operator is responsible for ensuring compliance with all local regulations not taken into account.

### 2.2 Intended use

- The pump (set) must only be operated in the fields of application and within the use limits specified in the other applicable documents.
- Only operate pumps/pump sets which are in perfect technical condition.
- Do not operate the pump (set) in partially assembled condition.
- Only use the pump to handle the fluids described in the data sheet or product literature of the pump model or variant.
- Never operate the pump without the fluid to be handled.
- Observe the minimum flow rate and maximum flow rate indicated in the data sheet or product literature (e.g. to prevent overheating, cavitation damage, bearing damage).
- Do not throttle the flow rate on the suction side of the pump (to prevent cavitation damage).
- Consult the manufacturer about any use or mode of operation not described in the data sheet or product literature.

#### 2.2.1 Prevention of foreseeable misuse

- Observe all safety information and instructions in this manual.
- Never exceed the permissible application and operating limits specified in the data sheet or product literature regarding pressure, temperature, etc.



### 2.3 Personnel qualification and training

All personnel involved must be fully qualified to transport, install, operate, maintain and inspect the equipment this manual refers to.

The responsibilities, competence and supervision of all personnel involved in transport, installation, operation, maintenance and inspection must be clearly defined by the operator.

Deficits in knowledge must be rectified by means of training and instruction provided by sufficiently trained specialist personnel. If required, the operator can commission the manufacturer/supplier to train the personnel.

Training on the pump (set) must always be supervised by technical specialist personnel.

This device may be operated by **children** from the age of 8 as well as by persons of limited physical, sensory or mental abilities or lacking experience and knowledge, provided that they are supervised, they have been instructed on how to use this device safely and they understand the hazards it presents. It is impermissible for **children** to play with this device. **Children** must not clean the device or perform any **service work to be carried out by the operator** at the device without supervision.

### 2.4 Consequences and risks caused by non-compliance with this manual

- Non-compliance with these operating instructions will lead to forfeiture of warranty cover and of any and all rights to claims for damages.
- Non-compliance can, for example, have the following consequences:
  - Hazards to persons due to electrical, thermal, mechanical and chemical effects and explosions
  - Failure of important product functions
  - Failure of prescribed maintenance and servicing practices
  - Hazard to the environment due to leakage of hazardous substances

### 2.5 Safety awareness

In addition to the safety information contained in this operating manual and the intended use, the following safety regulations shall be complied with:

- Accident prevention, health regulations and safety regulations
- Explosion protection regulations
- Safety regulations for handling hazardous substances
- Applicable standards, directives and laws

### 2.6 Safety information for the user/operator

- Fit protective equipment (e.g. contact guards) supplied by the operator for hot, cold or moving parts, and check that the equipment functions properly.
- Do not remove any protective equipment (e.g. contact guards) during operation.
- Provide the personnel with protective equipment and make sure it is used.
- Contain leakages (e.g. at the shaft seal) of hazardous fluids handled (e.g. explosive, toxic, hot) so as to avoid any danger to persons and the environment. Adhere to all relevant laws.
- Eliminate all electrical hazards. (In this respect refer to the applicable national safety regulations and/or regulations issued by the local energy supply companies.)
- If shutting down the pump does not increase potential risk, fit an emergency-stop control device in the immediate vicinity of the pump (set) during pump set installation.

### 2.7 Safety information for maintenance, inspection and installation

- Modifications or alterations of the pump (set) are only permitted with the manufacturer's prior consent.
- Use only original spare parts or parts/components authorised by the manufacturer. The use of other parts/components can invalidate any liability of the manufacturer for resulting damage.
- The operator ensures that maintenance, inspection and installation are performed by authorised, qualified specialist personnel who are thoroughly familiar with the manual.
- Only carry out work on the pump (set) during standstill of the pump.
- Only perform work on the pump set when it has been disconnected from the power supply (de-energised).
- The pump (set) must have cooled down to ambient temperature.
- Pump pressure must have been released and the pump must have been drained.
- When taking the pump set out of service always adhere to the procedure described in the manual. (⇒ Section 6.3.2, Page 27)
- Decontaminate pumps which handle fluids posing a health hazard.
- As soon as the work has been completed, re-install and re-activate any safety-relevant devices and protective devices. Before returning the product to service, observe all instructions on commissioning. (⇒ Section 6.1, Page 23)

### 2.8 Unauthorised modes of operation

Never operate the pump (set) outside the limits stated in the data sheet and in this manual.

The warranty relating to the operating reliability and safety of the supplied pump (set) is only valid if the equipment is used in accordance with its intended use.

### 3 Transport/Storage/Disposal

#### 3.1 Checking the condition upon delivery

1. On transfer of goods, check each packaging unit for damage.
2. In the event of in-transit damage, assess the exact damage, document it and notify KSB or the supplying dealer and the insurer about the damage in writing immediately.

#### 3.2 Transport

	<b>CAUTION</b>
	<p><b>Improper pump transport</b> Damage to the pump!</p> <ul style="list-style-type: none"> <li>▷ Never suspend the pump/pump set from the power cable.</li> <li>▷ Prevent the pump (set) from getting knocked or dropped.</li> </ul>

#### 3.3 Storage/preservation

	<b>CAUTION</b>
	<p><b>Damage during storage due to humidity, dirt or vermin</b> Corrosion/contamination of the pump (set)!</p> <ul style="list-style-type: none"> <li>▷ For outdoor storage cover the pump (set) or the packaged pump (set) and accessories with waterproof material.</li> </ul>

	<b>CAUTION</b>
	<p><b>Wet, contaminated or damaged openings and connections</b> Leakage or damage to the pump!</p> <ul style="list-style-type: none"> <li>▷ Clean and cover pump openings and connections as required prior to putting the pump into storage.</li> </ul>

If commissioning is to take place some time after delivery, we recommend that the following measures be taken for pump (set) storage.

Store the pump (set) in a dry, protected room where the atmospheric humidity is as constant as possible.

If properly stored indoors, the equipment is protected for a maximum of 12 months. New pumps/pump sets are supplied by our factory duly prepared for storage.

For storing a pump (set) which has already been operated, observe the instructions in (⇒ Section 6.3.2, Page 27) .

**Table 4:** Ambient conditions for storage

Ambient condition	Value
Relative humidity	80 % maximum
Ambient temperature	0 °C to + 40 °C

- Well-ventilated
- Dry
- Dust-free
- Shock-free
- Vibration-free

### 3.4 Return to supplier

1. Prior to returning the product to the supplier, flush and clean it, particularly if it has been used in noxious, explosive, hot or other hazardous fluids.
2. If the product has been used in fluids whose residues could lead to corrosion damage in the presence of atmospheric humidity or could ignite upon contact with oxygen, the product must also be neutralised and treated with anhydrous inert gas to ensure drying.
3. Always complete and enclose a certificate of decontamination when returning the product.  
Indicate any safety measures and decontamination measures taken.

	<b>NOTE</b>
	If required, a blank certificate of decontamination can be downloaded from the following web site: <a href="http://www.ksb.com/certificate_of_decontamination">www.ksb.com/certificate_of_decontamination</a>

### 3.5 Disposal

 	<b>⚠ DANGER</b>
	<p><b>Strong magnetic field in the rotor area</b>            Danger of death for persons with pacemaker!            Interference with magnetic data carriers, electronic devices, components and instruments!            Uncontrolled magnetic attraction forces between magnet-equipped components, tools or similar!</p> <p>▷ Keep a safety distance of at least 0.3 m.</p>

	<b>⚠ WARNING</b>
	<p><b>Fluids handled, consumables and supplies which are hot and/or pose a health hazard</b>            Hazard to persons and the environment!</p> <p>▷ Collect and properly dispose of flushing fluid and any fluid residues.            ▷ Wear safety clothing and a protective mask if required.            ▷ Observe all legal regulations on the disposal of fluids posing a health hazard.</p>

1. Dismantle the pump (set).  
Collect greases and other lubricants during dismantling.
2. Separate and sort the pump materials, e.g. by:
  - Metals
  - Plastics
  - Electronic waste
  - Greases and other lubricants
3. Dispose of materials in accordance with local regulations or in another controlled manner.

Electrical or electronic equipment marked with the adjacent symbol must not be disposed of in household waste at the end of its service life.

Contact your local waste disposal partner for returns.

If the used electrical or electronic equipment contains personal data, the operator is responsible for deleting it before the equipment is returned.

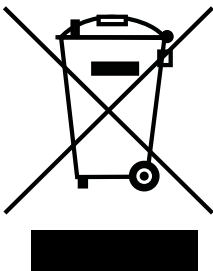

## 4 Description

### 4.1 General description

- High-efficiency circulator pumps with continuously variable speed control
- Non-self-priming in-line pump with integrated permanent magnet motor and electronic variable speed system

Pump for handling clean, non-aggressive fluids which are not chemically and mechanically aggressive to the pump materials.

### 4.2 Product information as per Regulation No. 1907/2006 (REACH)

For information as per chemicals Regulation (EC) No. 1907/2006 (REACH), see <http://www.ksb.com/reach>.

### 4.3 Designation

Example: Calio S 25-40-130

Table 5: Designation key

Code	Description	
Calio S	Type series	
25	Connection	
	15	Rp 1/2
	25	Rp 1
	30	Rp 1 1/4
40	Head H <sup>1)</sup> [m]	
	40	Head × 10 Example: 4 m × 10 = 40
130	Overall length	
	130	130 mm
	<sup>2)</sup>	See dimensions

### 4.4 Name plate

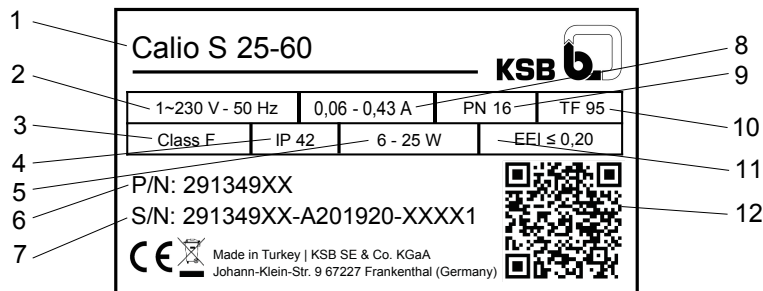

Fig. 1: Name plate (example)

1	Type series, size	7	Production number
2	Mains voltage, frequency	8	Current input
3	Thermal class	9	Pressure class
4	Enclosure	10	Temperature class
5	Power input	11	Energy efficiency index EEI
6	Material number	12	QR code

1) At flow rate Q = 0 m<sup>3</sup>/h  
2) Blank

Key to the production number Example: 291349XX-A201920-XXXX1

Table 6: Key to the production number

Code	Description
291349XX	Material number
2019	Year of production
20	Week of production
XXXX1	Consecutive number

#### 4.5 Design details

##### Design

- Maintenance-free high-efficiency wet rotor pump (glandless)

##### Drive

- High-efficiency permanent magnet synchronous motor, brushless, self-cooling, with continuously variable differential pressure control
- 1~230 V AC +/- 10%
- Frequency 50 Hz/60 Hz
- IP42 enclosure
- Thermal class F
- Temperature class TF 95
- Interference emissions EN 55014-1
- Interference immunity EN 55014-2
- Interference immunity EN 60335-2-51

##### Bearings

- Ceramic bearings

##### Connections

- Screw-ended

##### Operating modes

- Automatic mode with constant-pressure control or proportional-pressure control
- Open-loop control via setpoint setting

##### Automatic functions

- Continuously variable speed adjustment depending on the mode of operation
- Soft start (limitation of starting current)
- Full motor protection with integrated trip electronics
- Setback operation

##### Manual functions

- Setting the operating mode
- Setting the differential pressure setpoint
- Setting the speed level
- Vent function
- Deblocking the rotor

##### Signalling functions and display functions

- Alternating display of flow rate, head and electrical input power
- Error codes indicated on the display

4.6 Configuration and function

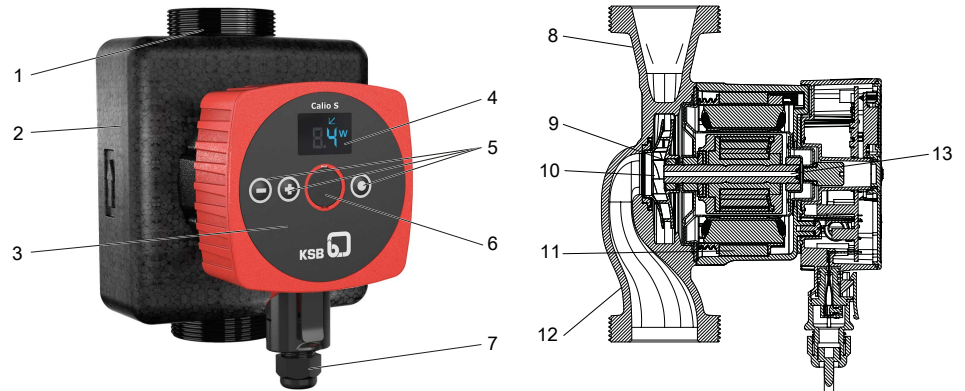

Fig. 2: Illustration of the pump set

1	Pump casing	8	Discharge nozzle
2	Thermal insulation shell	9	Radial plain bearing
3	Control panel	10	Impeller
4	Display	11	Motor
5	Control element (3 control buttons)	12	Suction nozzle
6	Vent plug / deblocking	13	Motor shaft
7	Plug-type connector for power supply		

**Design** The pump is designed with a radial fluid inlet (suction nozzle) and a radial outlet (discharge nozzle) arranged on the same axis. The impeller is rigidly connected to the motor shaft. Mechanical sealing is not required as the rotating assembly is completely isolated from the stator winding. The rotating assembly is lubricated and cooled by the fluid handled. The motor housing is equipped with a plug-type connector. The lubricating system and high-quality ceramic bearings ensure smooth running and a long service life. The integrated continuously variable differential pressure control and operating software enable an optimum adjustment of the pump to changing operating conditions and minimise operating costs. The combination of an efficient hydraulic system with a high-efficiency electric motor makes sure that the input power is converted into hydraulic energy as efficiently as possible.

**Function** The fluid enters the pump via the suction nozzle (12) and is accelerated outward in a cylindrical flow by the rotating impeller (10). In the flow passage of the pump casing the kinetic energy of the fluid is converted into pressure. The fluid is pumped to the discharge nozzle (8), where it leaves the pump. The shaft runs in radial plain bearings (9), which are supported by the motor (11).

**4.7 Noise characteristics**

Average sound pressure level  $\leq 30$  dB (A)

**4.8 Scope of supply**

Depending on the model, the following items are included in the scope of supply:

- Pump set
- Sealing elements
- Electrical plug-type connector
- Two-piece thermal insulation shell (only for overall length  $\geq 180$  mm)
- Installation/operating manual

**4.9 Dimensions and weight**

For dimensions and weights please refer to the type series booklet of the pump (set).



**4.10 Accessories**

No accessories available.



## 5 Installation at Site

### 5.1 Safety regulations

	<div style="background-color: #e67e22; color: white; padding: 5px;"><b>⚠ DANGER</b></div> <p><b>Installation in potentially explosive atmospheres</b> Explosion hazard!</p> <ul style="list-style-type: none"> <li>▷ Never install the pump in potentially explosive atmospheres.</li> <li>▷ Observe the information given in the data sheet and on the name plates of the pump system.</li> </ul>
	<div style="background-color: #e67e22; color: white; padding: 5px;"><b>⚠ DANGER</b></div> <p><b>Use for drinking water or foodstuff applications</b> Danger of poisoning!</p> <ul style="list-style-type: none"> <li>▷ Never use the pump for drinking water or foodstuff applications.</li> </ul>
	<div style="background-color: #f1c40f; padding: 5px;"><b>CAUTION</b></div> <p><b>Improper installation of the pump set</b> Damage to the pump set!</p> <ul style="list-style-type: none"> <li>▷ Observe the permissible ambient conditions and the pump set's type of enclosure.</li> <li>▷ Observe the permissible ambient temperatures. Ambient temperatures &lt; 0 °C are not permitted.</li> <li>▷ In the event of outdoor installation, fit a protective roof to protect the pump set from the weather (e. g. sun, rain, snow).</li> </ul>





### 5.2 Checks to be carried out prior to installation

Before beginning with the installation check the following:

- The pump set can be operated on the power supply network according to the data on the name plate. (⇒ Section 4.4, Page 13)
- The fluid to be handled matches the description of suitable fluids. (⇒ Section 6.2.5.1, Page 26)
- All structural work required has been checked and prepared in accordance with the dimensions in the outline drawing.

### 5.3 Installing the pump set

	<div style="background-color: #e67e22; color: white; padding: 5px;"><b>⚠ DANGER</b></div> <p><b>Leakage at the pump</b> Hot fluids escaping!</p> <ul style="list-style-type: none"> <li>▷ Fit the sealing elements and make sure they are positioned correctly.</li> </ul>
---	--

	<p><b>CAUTION</b></p>
	<p><b>Ingress of fluid into the motor</b>          Damage to the pump set!</p> <ul style="list-style-type: none"> <li>▷ Install the pump set with the pump shaft in a horizontal position. Connect the piping without transmitting any stresses and strains.</li> <li>▷ Never install the pump set with the motor terminal box pointing downwards.</li> <li>▷ Undo the hexagon socket head cap screws. Then turn the motor housing.</li> </ul>
	<p><b>CAUTION</b></p>
	<p><b>Air entering the pump</b>          Damage to vertically installed pump sets whose direction of flow is downwards!</p> <ul style="list-style-type: none"> <li>▷ Fit a vent valve at the highest point of the suction line.</li> </ul>
	<p><b>NOTE</b></p>
	<p>Installing shut-off valves upstream and downstream of the pump set is recommended. Make sure that no leakage water can drip onto the drive or terminal box.</p>
	<p><b>NOTE</b></p>
	<p>The direction of flow of a vertically installed pump should be upwards.</p>
	<p><b>NOTE</b></p>
	<p>Do not install the pump at the lowest point of the system to prevent any impurities from collecting in the pump.</p>

The control panel can be turned. The position must be effected with the pump set removed from the system.

1. Undo and store the 4 hexagon socket head cap screws.
2. Rotate the drive unit until it has reached the required position. Compare it against the permissible installation positions. Adjust the position if required.
3. Fit and tighten the 4 hexagon socket head cap screws again.

**Permissible installation positions**

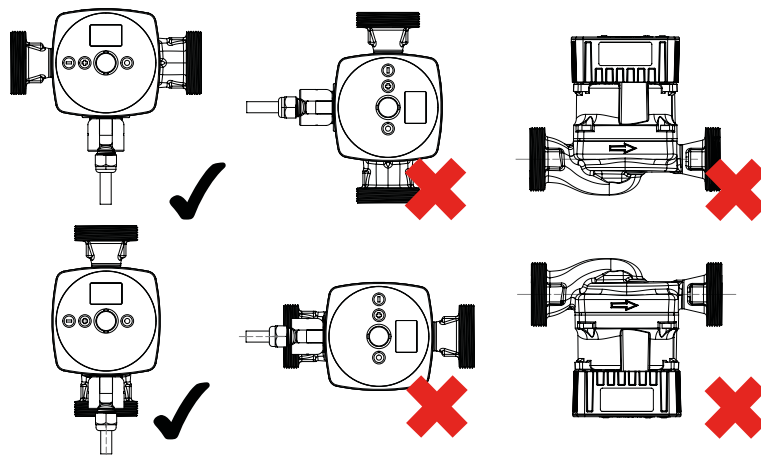

Fig. 3: Permissible installation positions

	<b>⚠ DANGER</b>
	<p><b>Leakage at the pump</b> Leakage of hot fluids!</p> <ul style="list-style-type: none"> <li>▷ Insert the O-ring in the correct position.</li> </ul>

**Screw-ended pump**

1. Position the pump set as indicated in an easily accessible place.
  - ⇒ An arrow on the pump casing and thermal insulation shell indicates the direction of flow.
2. Accurately insert the sealing element.
3. Connect the pump and piping with a pipe union.
4. Tighten the pipe union hand-tight with an assembly tool (e.g. pipe wrench).
5. Accurately insert the sealing element in the opposite pipe union.
6. Tighten the pipe union hand-tight with an assembly tool (e.g. pipe wrench).

**5.4 Connecting the piping**

	<b>⚠ WARNING</b>
	<p><b>Hot surface</b> Risk of burns</p> <ul style="list-style-type: none"> <li>▷ Never touch a pump set when it is in operation.</li> </ul>

	<b>⚠ WARNING</b>
	<p><b>Impermissible loads acting on the pump nozzles</b> Risk of burns by hot fluids escaping!</p> <ul style="list-style-type: none"> <li>▷ Do not use the pump as an anchorage point for the piping.</li> <li>▷ Anchor the pipes in close proximity to the pump and connect them without transmitting any stresses or strains.</li> <li>▷ Take appropriate measures to compensate for thermal expansion of the piping.</li> </ul>

	<b>CAUTION</b>
	<p><b>Contamination/dirt in the piping</b> Damage to the pump!</p> <ul style="list-style-type: none"> <li>▷ Flush the piping prior to commissioning or replacing the pump. Remove any foreign matter.</li> </ul>

	<b>NOTE</b>
	<p>Installing check and shut-off elements in the system is recommended, depending on the type of plant and pump. However, such elements must not obstruct proper drainage or hinder disassembly of the pump.</p>

- ✓ Suction lift lines have been laid with a rising slope, suction head lines with a downward slope towards the pump.
  - ✓ The nominal diameters of the pipelines are equal to or greater than the nominal diameters of the pump nozzles.
  - ✓ The pipelines have been anchored in close proximity to the pump and connected without transmitting any stresses or strains.
1. Thoroughly clean, flush and blow through all vessels, pipelines and connections (especially of new installations).

5.5 Enclosure/insulation

	<p><b>WARNING</b></p> <p><b>The pump takes on same temperature as the fluid handled</b> Risk of burns!</p> <ul style="list-style-type: none"> <li>▷ Insulate the volute casing.</li> <li>▷ Fit protective equipment.</li> </ul>
	<p><b>CAUTION</b></p> <p><b>Heat building up at motor housing and pump casing</b> Pump overheating!</p> <ul style="list-style-type: none"> <li>▷ Never insulate the motor and electronic system housings.</li> </ul>
	<p><b>NOTE</b></p> <p>Two-piece thermal insulation shell supplied for overall length <math>\geq 180</math> mm.</p>

5.6 Electrical connection

	<p><b>DANGER</b></p> <p><b>Electrical connection work by unqualified personnel</b> Danger of death from electric shock!</p> <ul style="list-style-type: none"> <li>▷ Always have the electrical connections installed by a trained and qualified electrician.</li> <li>▷ Observe regulations IEC 60364.</li> </ul>
	<p><b>DANGER</b></p> <p><b>Work performed on an energised plug-type connector</b> Danger of death from electric shock!</p> <ul style="list-style-type: none"> <li>▷ Switch off the power supply prior to commencing work and ensure that it cannot be switched on again unintentionally.</li> </ul>
	<p><b>DANGER</b></p> <p><b>Plastic housing opened</b> Risk of fatal injury due to electric shock!</p> <ul style="list-style-type: none"> <li>▷ The plastic housing must not be opened.</li> </ul>
	<p><b>WARNING</b></p> <p><b>Incorrect connection to the mains</b> Damage to the mains network, short circuit!</p> <ul style="list-style-type: none"> <li>▷ Observe the technical specifications of the local energy supply companies.</li> </ul>
	<p><b>NOTE</b></p> <p>The cable must be of type H05VV-F 3G1.5 or similar, with an outside diameter <math>\geq 7.2</math> mm. If a conductor cross-section of <math>0.5 \text{ mm}^2</math> is selected (which is not recommended), the cable must not exceed a length of 2 m in accordance with EN 60335-1.</p>

	<b>NOTE</b>
	<p>Connection to power supply must be effected by means of a fixed power cable with a minimum cross-section of <math>3 \times 1.5 \text{ mm}^2</math>.</p> <p>Connection to the power supply must be effected by a power cable which is fitted with an all-pole isolating switch with a minimum contact opening of 3 mm.</p> <p>If the power cable of the device is damaged, have it replaced by the manufacturer, a customer service technician or a similarly qualified person. See EN 60335-1.</p>

### 5.6.1 Connecting the power cable

**Table 7:** Power cable dimensions

Power cable dimensions	Values
Outside diameter	5,5 - 10,0 mm
Cross-section	0,5 - 1,5 mm <sup>2</sup> (solid or stranded <sup>3)</sup> )

1. Verify the mains voltage at the site against the data on the name plate.
2. Switch off the power supply and make sure it cannot be switched on again unintentionally.
3. Fit the union nut and joint ring on the power cable.
4. Guide the power cable through the plug housing until the cable ends are freely accessible.
5. Strip the power cable as shown in the following illustration.  
Strip about 18 mm of the earth conductor sheath. Strip about 13 mm of the neutral conductor sheath and L conductor sheath.  
Strip 6 mm of each core's sheath as a minimum.

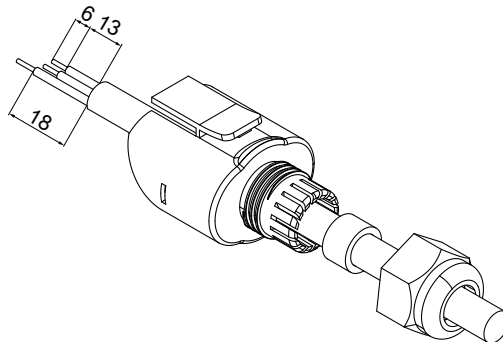

**Fig. 4:** Stripping the power cable [mm]

6. Connect the cores at the contact insert.

<sup>3)</sup> Fit wire end sleeves on stranded/flexible cores.

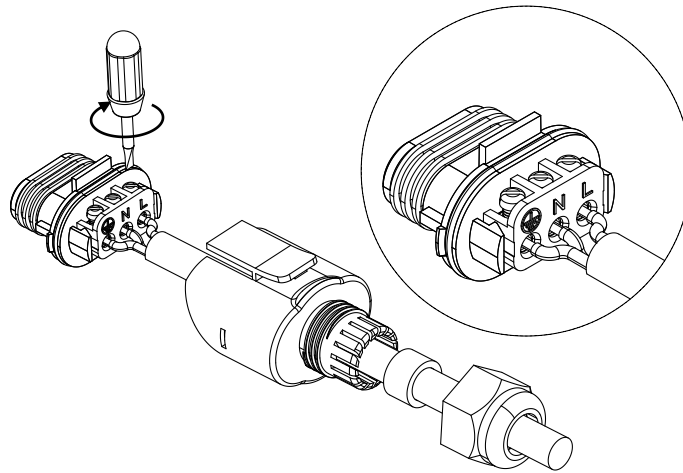

**Fig. 5:** Connecting the cores at the contact insert

L	Conductor / phase (230 V)
N	Neutral conductor
⏚	Earthing

- Slide the contact insert into the plug housing until you can hear it engage. Make sure the projection is positioned correctly.

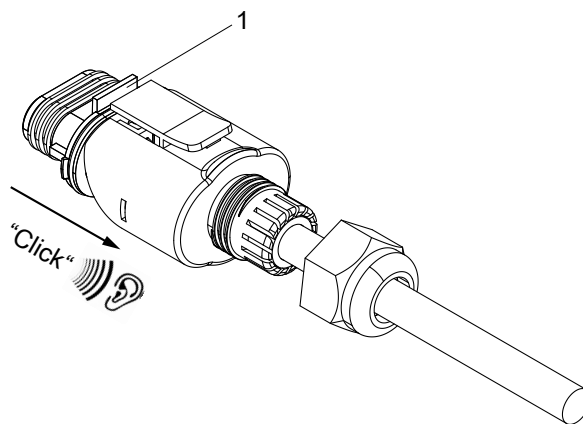

**Fig. 6:** Fastening the contact insert to the plug housing

1	Projection
---	------------

- Screw the union nut and joint ring hand-tight onto the thread at the plug housing.
- Connect the plug-type connector at the pump set.

## 6 Commissioning/Start-up/Shutdown



### 6.1 Commissioning/Start-up

#### 6.1.1 Prerequisites for commissioning/start-up

Before commissioning/starting up the pump set, make sure that the following conditions are met:





- The pump set has been properly connected to the power supply and is equipped with all protection devices. (⇒ Section 5.6, Page 20)
- The system piping has been cleaned. (⇒ Section 5.4, Page 19)
- The pump has been primed with the fluid to be handled. The pump has been vented. (⇒ Section 6.1.2, Page 23)

#### 6.1.2 Priming and venting the pump

	<p><b>⚠ WARNING</b></p>
	<p><b>Hot fluid escaping under pressure when the vent plug is opened</b>                  Risk of electric shock!                  Risk of scalding!</p> <ul style="list-style-type: none"> <li>▷ Loosen the vent plug; do not remove it.</li> <li>▷ Protect the electric components against escaping fluid.</li> <li>▷ Wear protective clothing (e.g. gloves).</li> </ul>
	<p><b>CAUTION</b></p>
	<p><b>Increased wear due to dry running</b>                  Damage to the pump set!</p> <ul style="list-style-type: none"> <li>▷ Never operate the pump set without liquid fill.</li> <li>▷ Never close the shut-off element in the suction line and/or supply line during pump operation.</li> <li>▷ Observe the specified minimum pressure for operating the pump set.</li> <li>▷ Always operate the pump set within the permissible operating range.</li> </ul>

1. Completely open the shut-off element in the suction line.
2. During operation at maximum speed loosen the vent plug with a suitable tool until some of the fluid handled escapes.
3. Tighten the vent plug to a maximum tightening torque of 0.5 Nm.
4. Repeat the procedure until all air has escaped.

6.1.3 Start-up

	<p style="background-color: #e67e22; color: white; padding: 5px;"><b>⚠ DANGER</b></p> <p><b>Non-compliance with the permissible pressure and temperature limits if the pump is operated with the suction and discharge lines closed.</b> Hot fluids escaping!</p> <ul style="list-style-type: none"> <li>▸ Never operate the pump with the shut-off elements in the suction line and/or discharge line closed.</li> <li>▸ Only start up the pump set against a slightly or completely open discharge-side shut-off element.</li> </ul>
	<p style="background-color: #e67e22; color: white; padding: 5px;"><b>⚠ DANGER</b></p> <p><b>Excessive temperatures due to insufficient lubrication of the plain bearings</b> Damage to the pump set!</p> <ul style="list-style-type: none"> <li>▸ Never operate the pump set without liquid fill.</li> <li>▸ Prime the pump as per operating instructions.</li> <li>▸ Always operate the pump within the permissible operating range.</li> </ul>
	<p style="background-color: #f1c40f; padding: 5px;"><b>⚠ WARNING</b></p> <p><b>Hot surfaces (Pump and piping take on the temperature of the fluid handled.)</b> Risk of burns!</p> <ul style="list-style-type: none"> <li>▸ Do not touch hot surfaces.</li> </ul>
	<p style="background-color: #f1c40f; padding: 5px;"><b>CAUTION</b></p> <p><b>Abnormal noises, vibrations, temperatures or leakage</b> Damage to the pump!</p> <ul style="list-style-type: none"> <li>▸ Switch off the pump (set) immediately.</li> <li>▸ Eliminate the causes before returning the pump set to service.</li> </ul>

- ✓ The system piping has been cleaned.
- ✓ Pump, suction line and inlet tank (if fitted) have been vented and primed with the fluid to be handled.
- ✓ The priming lines and venting lines have been closed.
  1. Fully open the shut-off element in the suction head line/suction lift line.
  2. Close or slightly open the shut-off element in the discharge line.
  3. Start up the motor.



### 6.2 Operating limits

	<b>⚠ DANGER</b>
	<p><b>Non-compliance with operating limits for pressure, temperature, fluid handled and speed</b> Hot fluids escaping!</p> <ul style="list-style-type: none"> <li>▷ Comply with the operating data indicated in the data sheet.</li> <li>▷ Avoid prolonged operation against a closed shut-off element.</li> <li>▷ Never operate the pump at product temperatures exceeding those specified in the data sheet or on the name plate.</li> </ul>

#### 6.2.1 Frequency of starts

	<b>CAUTION</b>
	<p><b>Excessively high frequency of starts</b> Damage to the pump set!</p> <ul style="list-style-type: none"> <li>▷ Do not exceed the values for the frequency of starts.</li> </ul>

Maximum 20 starts per hour via the power supply.

#### 6.2.2 Ambient temperature

	<b>CAUTION</b>
	<p><b>Operation outside the permissible ambient temperature</b> Damage to the pump (set)!</p> <ul style="list-style-type: none"> <li>▷ Observe the specified limits for permissible ambient temperatures.</li> </ul>

Observe the following parameters and values during operation:

**Table 8:** Permissible ambient temperatures specified for the fluid temperature

Fluid temperature [°C]	Permissible ambient temperature [°C]
≤ + 95	+ 40

#### 6.2.3 Minimum inlet pressure

The minimum inlet pressure  $p_{min}$  at the pump suction nozzle serves to avoid cavitation noises at an ambient temperature of +40 °C and the indicated fluid temperature  $T_{max}$ .

The indicated values are applicable up to 300 m above sea level. For installation at altitudes > 300 m, an allowance of 0.01 bar / 100 m must be added.

**Table 9:** Minimum inlet pressure  $p_{min}$  specified for the fluid temperature  $T_{max}$ .

Fluid temperature [°C]	Minimum inlet pressure [bar]
5 to 75	0,05
76 to 110	0,4

6.2.4 Maximum operating pressure

	<b>CAUTION</b>
	<p><b>Permissible operating pressure exceeded</b>            Damage to connections and seals!</p> <ul style="list-style-type: none"> <li>▸ Never exceed the operating pressure specified in the data sheet.</li> </ul>

The maximum operating pressure is 10 bar.

6.2.5 Fluid handled

6.2.5.1 Permissible fluids to be handled

	<b>⚠ DANGER</b>
	<p><b>Use for drinking water or foodstuff applications</b>            Danger of poisoning!</p> <ul style="list-style-type: none"> <li>▸ Never use the pump for drinking water or foodstuff applications.</li> </ul>

	<b>CAUTION</b>
	<p><b>Unsuitable fluids</b>            Damage to the pump!</p> <ul style="list-style-type: none"> <li>▸ Never use the pump to handle corrosive, combustible or explosive fluids.</li> <li>▸ Never use the pump to handle waste water or abrasive fluids.</li> <li>▸ Do not use the pump for foodstuff applications.</li> </ul>

- Heating water to VDI 2035. If the glycol content equals or exceeds 20 %, check and verify the operating data.
- Pure, thin, non-aggressive, non-explosive and non-gaseous fluids not containing any mineral oil, solids or long fibres
- Fluids with a viscosity of max. 10 mm<sup>2</sup>/s

6.2.5.2 Density of the fluid handled

	<b>CAUTION</b>
	<p><b>Impermissibly high density of the fluid handled</b>            Motor overload!</p> <ul style="list-style-type: none"> <li>▸ Observe the information on fluid density in the data sheet.</li> </ul>

The power input of the pump set will change in proportion to the density of the fluid handled.

6.2.5.3 Fluid temperature

	<b>CAUTION</b>
	<p><b>Incorrect fluid temperature</b>                  Damage to the pump (set)!</p> <p>▸ Only operate the pump (set) within the temperature limits indicated.</p>

**Table 10:** Temperature limits of the fluid handled

Permissible fluid temperature	Value
Maximum	+ 95 °C
Minimum	+ 2 °C

The fluid temperature has an impact on the minimum inlet pressure.  
 (⇒ Section 6.2.3, Page 25)

6.3 Shutdown

6.3.1 Shutdown

	<b>NOTE</b>
	<p>If the discharge line is equipped with a non-return or check valve, the shut-off element may remain open provided that the system conditions and system regulations are considered and observed.</p>

- ✓ The shut-off element in the suction line is and remains open.
  1. Close the shut-off element in the discharge line.
  2. Switch off the motor and make sure the pump set runs down smoothly to a standstill.

For prolonged shutdown periods

	<b>CAUTION</b>
	<p><b>Risk of freezing during prolonged pump shutdown periods</b>                  Damage to the pump!</p> <p>▸ Drain the pump and the cooling/heating chambers (if any) or otherwise protect them against freezing.</p>

1. Close the shut-off element in the suction line.

6.3.2 Measures to be taken for shutdown



**The pump (set) remains installed**

- ✓ Sufficient fluid is supplied for the functional check run of the pump.
  1. For prolonged shutdown periods, start up the pump (set) regularly between once a month and once every three months for approximately five minutes.
    - ⇒ This will prevent the formation of deposits within the pump and the pump intake area.

**The pump (set) is removed from the pipe and stored**

- ✓ The pump has been drained properly (⇒ Section 8.2, Page 40) and the safety instructions for dismantling the pump have been observed.
  1. Observe any additional instructions and information provided.  
 (⇒ Section 3, Page 11)

### 6.4 Returning to service

	 <b>WARNING</b>
	<p><b>Failure to re-install or re-activate protective devices</b>            Risk of injury from moving parts or escaping fluid!</p> <ul style="list-style-type: none"> <li>▷ As soon as the work is completed, properly re-install and re-activate any safety-relevant devices and protective devices.</li> </ul>

For returning the equipment to service, observe the sections on commissioning/start-up (⇒ Section 6.1, Page 23) and the operating limits (⇒ Section 6.2, Page 25) .

In addition, carry out all servicing/maintenance operations before returning the pump (set) to service. (⇒ Section 8, Page 39)

## 7 Operation

### 7.1 Control panel

All settings are made using the control element on the housing front. The control element comprises three control pushbuttons.

**Table 11:** Overview of control buttons

Control button	Function
	<ul style="list-style-type: none"> <li>Change the operating mode.</li> <li>Turn on display backlighting.</li> <li>Save the setpoint.</li> </ul>
	<ul style="list-style-type: none"> <li>Increase the setting.</li> <li>Increase the setpoint.</li> </ul>
	<ul style="list-style-type: none"> <li>Reduce the setting.</li> <li>Reduce the setpoint.</li> </ul>

#### 7.1.1 Display

The measured electrical input power, the flow rate and the head are shown as 3-digit numbers on the integrated display. The values are displayed with the corresponding units.







**Fig. 7:** Display

#### Symbols

The symbols indicate operating modes, functions and settings. Lit symbols indicate the active operating mode, function or setting.

**Table 12:** Symbols key

Symbol	Description	Unit
m <sup>3</sup> /h	Flow rate <ul style="list-style-type: none"> <li>Symbol lights up.</li> <li>Display shows the flow rate.</li> </ul>	m <sup>3</sup> /h
W	Measured electrical input power <ul style="list-style-type: none"> <li>Symbol lights up.</li> <li>Display shows the electrical power.</li> </ul>	W
m	Head <ul style="list-style-type: none"> <li>Symbol lights up.</li> <li>Display shows the head.</li> </ul>	m
E	Constant-pressure Control operating mode <ul style="list-style-type: none"> <li>Symbol lights up when this operating mode is active.</li> </ul>	-
K	Proportional-pressure Control operating mode <ul style="list-style-type: none"> <li>Symbol lights up when this operating mode is active.</li> </ul>	-
eco	Dynamic Control operating mode <ul style="list-style-type: none"> <li>Symbol lights up when this operating mode is active.</li> </ul>	-

Symbol	Description	Unit
	Open-loop Control operating mode <ul style="list-style-type: none"> <li>▪ Symbol lights up when this operating mode is active.</li> <li>▪ The bar diagram shows the active speed level.</li> </ul>	-
	Setback Operation function <ul style="list-style-type: none"> <li>▪ Symbol lights up when this operating mode is active.</li> </ul>	-
	Service mode (only for KSB Service) <ul style="list-style-type: none"> <li>▪ Symbol lights up when this function is active.</li> <li>▪ Control panel remains operational when drive is stopped.</li> </ul>	-
	Fault message (e.g. error code E8) <ul style="list-style-type: none"> <li>▪ An error code (E01 - E09) is shown on the display.</li> </ul>	-

## 7.2 Operating modes

### 7.2.1 Information on settings

For common applications such as two-pipe systems Proportional-pressure Control ( $\Delta p-v$ ) is the recommended operating mode. This operating mode offers an extended control range with additional potential savings compared to Constant-pressure Control ( $\Delta p-c$ ). Depending on the balancing of branch circuits, undersupply may occur at a consumer installation.

Constant-pressure Control operating mode ( $\Delta p-c$ ) can optionally be selected for underfloor heating systems, for example. If noises are audible at low flow rates, select the Proportional-pressure Control operating mode ( $\Delta p-v$ ).

The setting of the head setpoint depends on the piping curve of the system and on the heat requirements. As standard the pump set is pre-set to Proportional-pressure Control ( $\Delta p-v$ ) operating mode.

**Table 13:** Standard setting of the head setpoint

Size	Head setpoint
	[m]
15-40-130	2
15-60-130	3
25-40-130	2
25-60-130	3
25-40	2
25-60	3
25-80	4
30-40	2
30-60	3
30-80	4

### 7.2.2 Constant-pressure control

#### Application

- Underfloor heating systems
- Solar pumps

Solar pumps require a high operating pressure to pump sufficient fluid through the heat exchanger. Proportional-pressure Control is not necessary as the thermostatic valves do not impact on the characteristic curve.

#### Function

In Constant-pressure Control the set head ② is maintained irrespective of the flow rate. The set differential pressure setpoint  $H_s$  is constant, situated between the maximum curve ① and the permissible flow rate range.

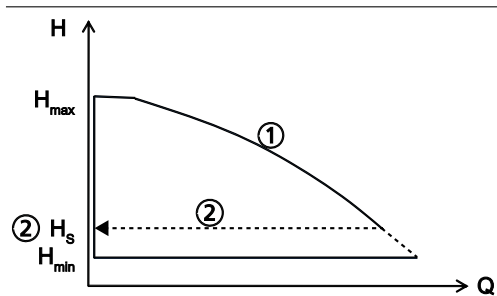

Fig. 8: Constant-pressure Control function

#### Setting

Table 14: Selecting Constant-pressure Control and the setpoint

	<p>Step 1: Activating the setting mode</p> <ul style="list-style-type: none"> <li>▪ Press and hold the control button (●) for 3 seconds <ul style="list-style-type: none"> <li>– This will activate the display backlighting.</li> <li>– The flashing symbol indicates the active operating mode.</li> </ul> </li> </ul>
	<p>Step 2: Selecting the Constant-pressure Control operating mode</p> <ul style="list-style-type: none"> <li>▪ Press the control button (●) for a minimum of 0.5 seconds until the symbol for Constant-pressure Control flashes.</li> </ul>
	<p>Step 3: Changing the setpoint</p> <ul style="list-style-type: none"> <li>▪ Increase or decrease the head setpoint by pressing the control buttons (+) or (-) respectively.</li> </ul>
<p>-</p>	<p>Step 4: Confirming the current setpoint</p> <ul style="list-style-type: none"> <li>▪ Press and hold the control button (●) for a minimum of 3 seconds. <ul style="list-style-type: none"> <li>– The set setpoint flashes and is saved.</li> </ul> </li> </ul>

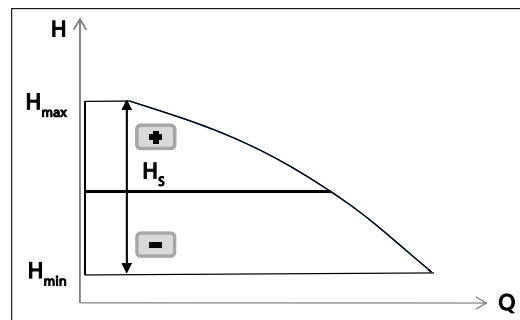

Fig. 9: Constant-pressure Control settings

### 7.2.3 Proportional-pressure control

#### Application

- Heating systems with radiators

The higher the flow rate, the higher the system's resistance. This is corrected by the pump set automatically increasing the head setpoint.

When setting the setpoint ensure that the selected control curve is suitable for the system characteristic curve:

- If the system characteristic curve is known (e.g. hydraulic balancing), select a control curve that is minimally above the characteristic curve. See type series booklet.
  - Control curve too low: undersupply
  - Control curve too high: increased energy input
- If the system characteristic curve is unknown, dynamic control is recommended. (⇒ Section 7.3.1, Page 35)
  - The pump set automatically recognises the system characteristic curve via the speed control system and optimises the operating point accordingly.

#### Function

Within the permissible flow rate range the Proportional-pressure Control decreases or increases the differential pressure setpoint between  $\frac{1}{2} H_s$  and  $H_s$  (factory-set) in a linear fashion with the flow rate.

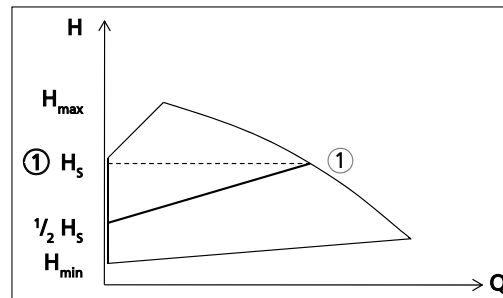

Fig. 10: Proportional-pressure Control function

#### Setting

Table 15: Selecting Proportional-pressure Control and the setpoint

	<p>Step 1: Activating the setting mode</p> <ul style="list-style-type: none"> <li>▪ Press and hold the control button (●) for 3 seconds                             <ul style="list-style-type: none"> <li>– This will activate the display backlighting.</li> <li>– The flashing symbol indicates the active operating mode.</li> </ul> </li> </ul>
	<p>Step 2: Selecting the Proportional-pressure Control operating mode</p> <ul style="list-style-type: none"> <li>▪ Press the control button (●) for a minimum of 0.5 seconds until the symbol for Proportional-pressure Control flashes.</li> </ul>
	<p>Step 3: Changing the setpoint</p> <ul style="list-style-type: none"> <li>▪ Increase or decrease the setpoint by pressing the control buttons (+) or (-) respectively.</li> </ul>
<p>-</p>	<p>Step 4: Confirming the current setpoint</p> <ul style="list-style-type: none"> <li>▪ Press and hold the control button (●) for a minimum of 3 seconds.                             <ul style="list-style-type: none"> <li>– The set setpoint flashes and is saved.</li> </ul> </li> </ul>



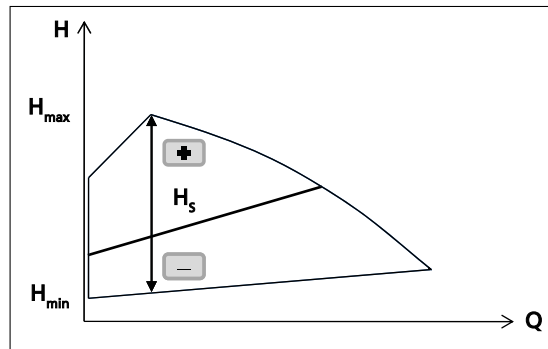

Fig. 11: Proportional-pressure Control settings

### 7.2.4 Open-loop control

#### Function

In Open-loop Control operating mode the pump set runs at a set speed. The speed can be set to one of three speed levels.

#### Setting

**Table 16:** Selecting Open-loop Control and the setpoint

	<p>Step 1: Activating the setting mode</p> <ul style="list-style-type: none"> <li>Press and hold the control button (●) for 3 seconds                     <ul style="list-style-type: none"> <li>This will activate the display backlighting.</li> <li>The flashing symbol indicates the active operating mode.</li> </ul> </li> </ul>
	<p>Step 2: Selecting the Open-loop Control operating mode</p> <ul style="list-style-type: none"> <li>Press the control button (●) for a minimum of 0.5 seconds until the symbol for Open-loop Control flashes.</li> </ul>
	<p>Step 3: Changing the setpoint</p> <ul style="list-style-type: none"> <li>Increase or decrease the setpoint by pressing the control buttons (+) or (-) respectively.                     <ul style="list-style-type: none"> <li>The bar diagram shows the active speed level.                             <ul style="list-style-type: none"> <li>Setpoint 1 = 1 bar flashes</li> <li>Setpoint 2 = 2 bars flash</li> <li>Setpoint 3 = 3 bars flash</li> </ul> </li> </ul> </li> </ul>
-	<p>Step 4: Confirming the current setpoint</p> <ul style="list-style-type: none"> <li>Press and hold the control button (●) for a minimum of 3 seconds.                     <ul style="list-style-type: none"> <li>The set setpoint flashes and is saved.</li> </ul> </li> </ul>

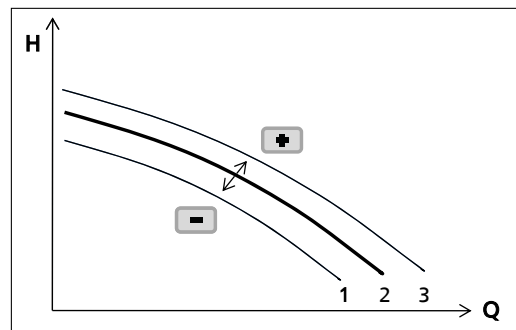

**Fig. 12:** Open-loop Control settings

**Table 17:** Speeds depending on the speed level

Size	Speed		
	Speed level 1	Speed level 2	Speed level 3
	[rpm]	[rpm]	[rpm]
15-40-130	1400	2150	2750
15-60-130	2150	3000	3400
25-40-130	1400	2150	2750
25-60-130	2150	3000	3400
25-40	1400	2150	2750
25-60	2150	3000	3400
25-80	2000	3000	3950
30-40	1400	2150	2750
30-60	2150	3000	3400
30-80	2000	3000	3950

7.3 Functions

7.3.1 Dynamic control

	<b>NOTE</b>
	Dynamic Control only works in combination with the Proportional-pressure Control operating mode.

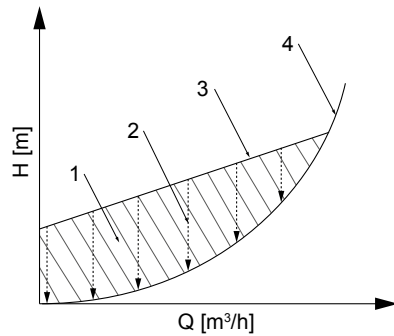

Fig. 13: Principle of dynamic control

1	Excess energy input	3	Control curve
2	Dynamic control	4	Minimum characteristic curve

The dynamic control (2) system detects when the selected control curve (3) is higher than the minimum characteristic curve<sup>4)</sup> (4). The control system shifts the control curve downwards and automatically reduces the energy input. To ensure sufficient supply the pump set switches to a higher control curve when the minimum characteristic curve is reached. The energy input is reduced (1) without any negative impact on the supply of the building.

The pump set is operated in an optimised way, even if the system characteristic curve is unknown; the noise at the thermostatic valves is reduced.

**Application**



- If the system characteristic curve is known (e.g. hydraulic balancing):
  - Set the setpoint manually. Select a control curve that is minimally above the characteristic curve. See type series booklet.
  - Activating dynamic control in addition is recommended. Even if the setpoint has been set to an optimum, excessive throttling of the thermostatic valves may occur in certain climatic conditions. Dynamic control will further optimise the operating point.
- If the system characteristic curve is unknown:
  - Use the standard settings and activate dynamic control. The pump set automatically recognises the system characteristic curve via the speed control system and optimises the operating point accordingly.

1157.811/06-EN

4) Characteristic curve at fully open thermostatic valves

Settings

**Table 18:** Enabling and disabling Dynamic Control

	<p>Step 1: Activating the setting mode</p> <ul style="list-style-type: none"> <li>▪ Press and hold the control button (●) for 3 seconds             <ul style="list-style-type: none"> <li>– This will activate the display backlighting.</li> <li>– The flashing symbol indicates the active operating mode.</li> </ul> </li> </ul>
	<p>Step 2: Selecting Dynamic Control</p> <ul style="list-style-type: none"> <li>▪ Press the control button (●) for a minimum of 0.5 seconds until the symbol for Dynamic Control flashes.</li> </ul>
	<p>Step 3: Enabling/disabling Dynamic Control</p> <ul style="list-style-type: none"> <li>▪ Enable or disable Dynamic Control by pressing the control buttons (+) or (-) respectively.             <ul style="list-style-type: none"> <li>– 0 = Dynamic Control disabled</li> <li>– 1 = Dynamic Control enabled</li> </ul> </li> </ul>
<p>-</p>	<p>Step 4: Saving the Dynamic Control status</p> <ul style="list-style-type: none"> <li>▪ Press and hold the control button (●) for a minimum of 3 seconds.             <ul style="list-style-type: none"> <li>– The set status flashes and is saved.</li> </ul> </li> </ul>

**7.3.2 Setback operation**

**Function**

If the Setback Operation function is enabled, the pump set identifies minimum heat demand when the fluid temperature sinks continuously. The pump set automatically reduces the setpoint by 30 %. When heat demand rises again, the pump set reverts to its previous setpoint. For applications with small differences between supply temperature and return temperature disabling the Setback Operation is recommended (e.g. for underfloor heating systems combined with condensing boilers or heat pumps).

The pump set switches to night mode (setback operation) when:

- The fluid temperature sinks by 15 °C within 2 hours.

The pump set reverts to day mode when:

- The fluid temperature rises by 3 °C.
- The pump set has been in night mode for more than 7 hours.

The figure below illustrates an example of the criteria used by the boiler and pump set to switch between day mode and night mode:

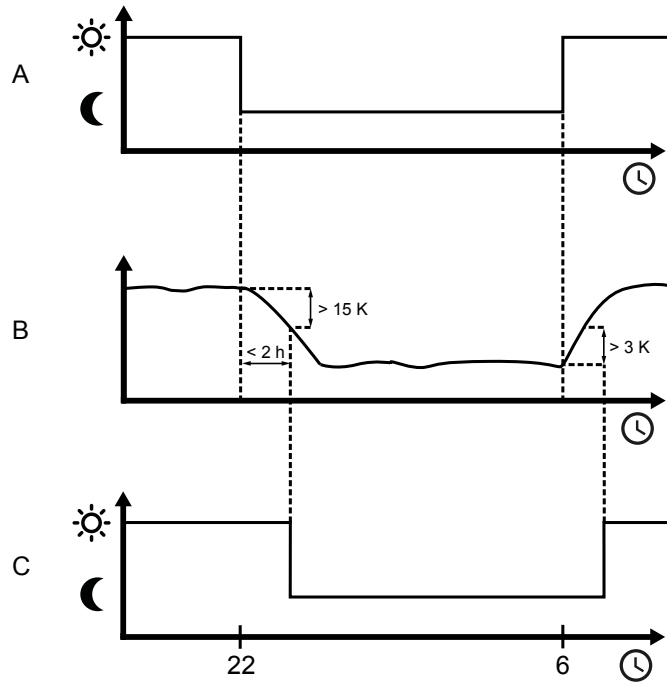

Fig. 14: Switchover between day mode and night mode

A	Boiler mode
B	Fluid temperature
C	Pump mode

Setting

Table 19: Enabling and disabling Setback Operation

	<p>Step 1: Activating the setting mode</p> <ul style="list-style-type: none"> <li>Press and hold the control button (●) for 3 seconds                     <ul style="list-style-type: none"> <li>This will activate the display backlighting.</li> <li>The flashing symbol indicates the active operating mode.</li> </ul> </li> </ul>
	<p>Step 2: Selecting Setback Operation</p> <ul style="list-style-type: none"> <li>Press the control button (●) for a minimum of 0.5 seconds until the symbol for Setback Operation flashes.</li> </ul>
	<p>Step 3: Enabling/disabling Setback Operation</p> <ul style="list-style-type: none"> <li>Enable or disable Setback Operation by pressing the control buttons (+) or (-) respectively.                     <ul style="list-style-type: none"> <li>0 = Setback Operation disabled</li> <li>1 = Setback Operation enabled</li> </ul> </li> </ul>
<p>-</p>	<p>Step 4: Saving the Setback Operation status</p> <ul style="list-style-type: none"> <li>Press and hold the control button (●) for a minimum of 3 seconds.                     <ul style="list-style-type: none"> <li>The set status flashes and is saved.</li> <li>When the status has been saved successfully, the symbol "nd" (night derating) is shown on the display.</li> </ul> </li> </ul>

1157.811/06-EN

### 7.3.3 Protective functions

#### Function

The electronic motor protection automatically reduces the pump power in the event of overloading.

#### Available protective functions:

- Protection against overheating
- Voltage monitoring
- Locked rotor

#### Settings

None

### 7.3.4 Saving data

The operating data of the pump set are saved. Data storage will be maintained also when the pump is switched off or disconnected from the power supply. When the pump set is switched on again, it will be operated with the data that were active before the pump set was last switched off.

### 7.3.5 Fault messages

#### Function

The pump set indicates errors by showing an error code on the display.



Fig. 15: Display of error code E8 (motor fault)

#### Example



Error E8 has occurred. The display flashes in 0.5-second intervals. Once the error has been remedied, the display will revert to the set operating mode. The settings of the pump set can then be changed again.

Table 20: Error codes, causes and response

Error code on the display	Cause	Status	Response
E01	Excessive temperature	Alarm	Pump stops.
E02	Overcurrent	Alarm	Pump stops.
E03	Internal fault	Alarm	Pump stops.
E04	Blocked rotor	Alarm	Pump stops.
E06	Voltage error	Alarm	Pump stops.
E08	Motor fault	Alarm	Pump stops.

## 8 Servicing/Maintenance

### 8.1 Servicing/maintenance/inspection

	<p style="background-color: #f4a460; padding: 2px;"><b>⚠ WARNING</b></p> <p><b>Hot water escaping under pressure when the vent plug is opened</b>          Risk of electric shock!          Risk of scalding!</p> <ul style="list-style-type: none"> <li>▷ Protect the electric components against escaping fluid.</li> <li>▷ Wear protective clothing (e.g. gloves).</li> </ul>
	<p style="background-color: #0070c0; color: white; padding: 2px;"><b>NOTE</b></p> <p>Any repairs on the pump (set) must only be performed by an authorised service partner. In the event of damage contact the heating system engineer.</p>

The pump set is almost maintenance-free.  
 If the pump set has not been in operation for a prolonged period of time or if the system severely is contaminated, the pump rotor can become blocked.

- Deblocking**
1. Close the valves on the suction side and discharge side.
  2. Remove the vent plug with a suitable tool.
  3. Unblock the pump rotor at the shaft end by turning it with a suitable tool.
  4. Tighten the vent plug to a maximum tightening torque of 0.5 Nm. Check that it is tightly sealed.

After maintenance work and inspection have been completed, proceed with the section on Returning to service (⇒ Section 6.4, Page 28) .

### 8.2 Drainage/cleaning

	<p><b>⚠ WARNING</b></p>
	<p><b>Fluids handled, consumables and supplies which are hot and/or pose a health hazard</b>  Hazard to persons and the environment!</p> <ul style="list-style-type: none"> <li>▷ Collect and properly dispose of flushing fluid and any fluid residues.</li> <li>▷ Wear safety clothing and a protective mask if required.</li> <li>▷ Observe all legal regulations on the disposal of fluids posing a health hazard.</li> </ul>

1. Always flush and clean the pump before transporting it to the workshop. Provide a certificate of decontamination for the pump.

### 8.3 Removing the pump set from the piping

	<p><b>⚠ DANGER</b></p>
	<p><b>Work performed on an energised plug-type connector</b>  Danger of death from electric shock!</p> <ul style="list-style-type: none"> <li>▷ Switch off the power supply prior to commencing work and ensure that it cannot be switched on again unintentionally.</li> </ul>



 	<p><b>⚠ DANGER</b></p>
	<p><b>Strong magnetic field in the rotor area</b>  Danger of death for persons with pacemaker!  Interference with magnetic data carriers, electronic devices, components and instruments!  Uncontrolled magnetic attraction forces between magnet-equipped components, tools or similar!</p> <ul style="list-style-type: none"> <li>▷ Keep a safety distance of at least 0.3 m.</li> </ul>

	<p><b>⚠ WARNING</b></p>
	<p><b>Strong magnetic field</b>  Danger of crushing injuries when pulling out the rotor!  Strong magnetic field can suddenly pull the rotor back into its original position!  Danger of magnetic parts near the rotor being attracted!</p> <ul style="list-style-type: none"> <li>▷ The rotor must only be removed from the motor housing by authorised specialist personnel.</li> <li>▷ Remove any magnetic parts from the vicinity of the rotor.</li> <li>▷ Keep the assembly area clean.</li> <li>▷ Keep a safety distance of at least 0.3 m from electronic components.</li> </ul>

	<p><b>⚠ WARNING</b></p>
	<p><b>Hot surface</b>  Risk of injury!</p> <ul style="list-style-type: none"> <li>▷ Allow the pump set to cool down to ambient temperature.</li> </ul>

1157.81/06-EN



	<p style="background-color: #FFD700; padding: 5px;"><b>CAUTION</b></p> <p><b>Strong magnetic field in the rotor area</b>          Interference with magnetic data carriers, electronic devices, components and instruments!          Uncontrolled magnetic attraction forces between magnetic components, tools or similar!</p> <ul style="list-style-type: none"> <li>▷ Remove any magnetic parts from the vicinity of the rotor.</li> <li>▷ Keep the assembly area clean.</li> </ul>
	<p style="background-color: #FFD700; padding: 5px;"><b>CAUTION</b></p> <p><b>Danger by strong magnetic field</b>          Negative impact on or damage to electrical devices!</p> <ul style="list-style-type: none"> <li>▷ The rotor must generally only be removed from the motor housing by authorised specialist personnel.</li> </ul>

- ✓ The pump set has been de-energised and secured against unintentional start-up.
  - ✓ The pump has cooled down to ambient temperature.
  - ✓ A container for collecting the fluid has been positioned underneath the pump set.
1. Close the shut-off elements.
  2. Disconnect the discharge nozzle and suction nozzle from the piping.
  3. Depending on the pump size / motor size, remove the supports from the pump set.
  4. Remove the complete pump set from the piping.

**8.3.1 Removing the power cable**

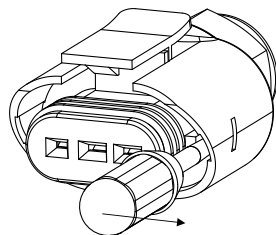

1. Switch off the power supply and make sure it cannot be switched on again unintentionally.
2. Disconnect the plug-type connector from the pump set.
3. Lever out the contact insert with a suitable tool as shown in the illustration.



**Fig. 16:** Removing the contact insert

4. Pull the contact insert out of the plug housing.

## 9 Trouble-shooting

	 <b>WARNING</b>
	<p><b>Improper work to remedy faults</b></p> <p>Risk of injury!</p> <p>▷ For any work performed to remedy faults, observe the relevant information given in this instruction manual and/or in the product literature provided by the accessories manufacturer.</p>

If problems occur that are not described in the following table, consultation with KSB Service is required.

- A Pump is running, but does not deliver
- B Pump does not start up or pump running irregularly
- C Pump running but not delivering water
- D Noises during pump operation

**Table 21:** Trouble-shooting

Error value	Possible cause	Remedy <sup>5)</sup>
A	<ul style="list-style-type: none"> <li>▪ See Fault messages (⇒ Section 7.3.5, Page 38)</li> <li>▪ Spanner symbol shown on display / Service mode activated</li> </ul>	<ul style="list-style-type: none"> <li>▪ Reset the control system. Check the power supply and fuses.</li> <li>▪ Disconnect the plug or press control buttons (+) and (-) simultaneously for 5 seconds until the spanner symbol disappears from the display (Service mode deactivated).</li> </ul>
B	<ul style="list-style-type: none"> <li>▪ Impurities in the pump</li> </ul>	<ul style="list-style-type: none"> <li>▪ (⇒ Section 8.1, Page 39)</li> </ul>
B	<ul style="list-style-type: none"> <li>▪ Blockage in the pump</li> </ul>	<ul style="list-style-type: none"> <li>▪ (⇒ Section 8.1, Page 39)</li> </ul>
C	<ul style="list-style-type: none"> <li>▪ Air in the system</li> <li>▪ Shut-off elements closed</li> </ul>	<ul style="list-style-type: none"> <li>▪ Vent the system and the pump. (⇒ Section 6.1.2, Page 23)</li> <li>▪ Open the shut-off elements.</li> </ul>
D	<ul style="list-style-type: none"> <li>▪ Power too high</li> <li>▪ System pressure too low</li> <li>▪ Air in the system</li> <li>▪ Pump running dry</li> </ul>	<ul style="list-style-type: none"> <li>▪ Reduce the differential pressure setpoint.</li> <li>▪ Increase the system pressure by filling more water into the boiler.</li> <li>▪ Vent the system and the pump. (⇒ Section 6.1.2, Page 23)</li> <li>▪ Prime the pump. (⇒ Section 6.1.2, Page 23)</li> </ul>

5) Release pump set pressure before attempting to remedy faults on parts which are subjected to pressure.

## 10 Related Documents

### 10.1 Sectional drawing with list of components

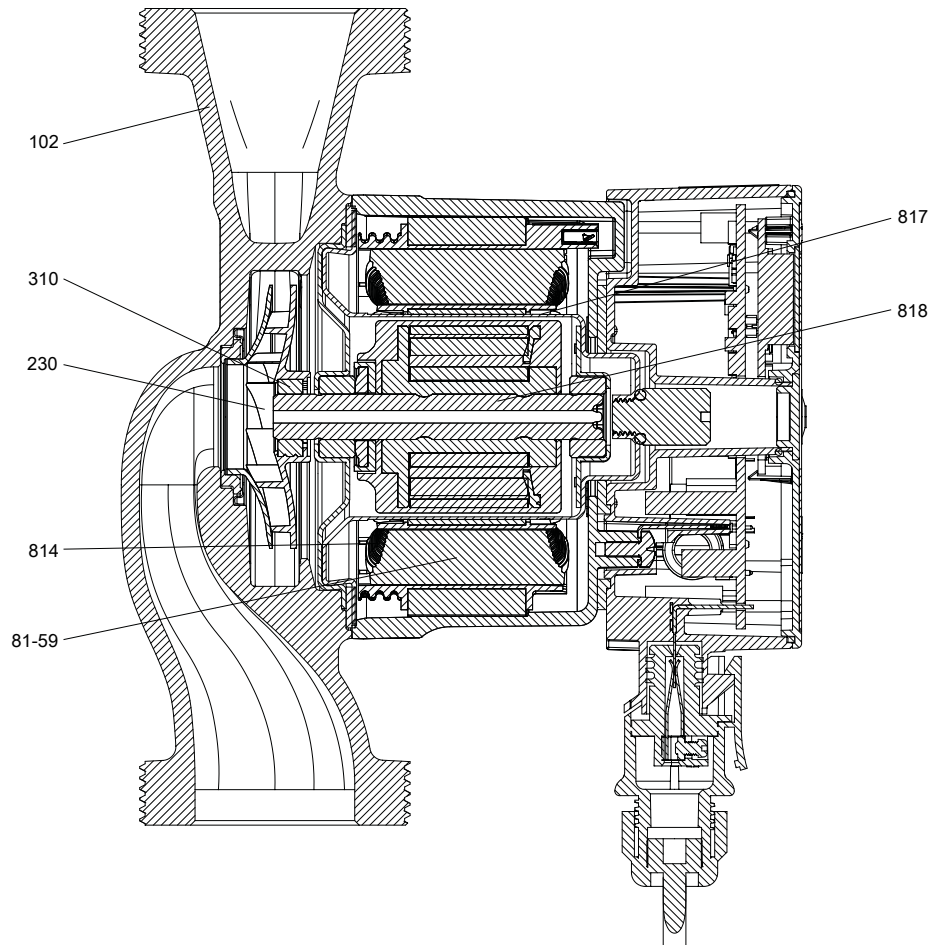

Fig. 17: Sectional drawing

Table 22: List of components

Part No.	Description	Part No.	Description
102	Volute casing	230	Impeller
310	Plain bearing	81-59	Stator
814	Copper winding	817	Can
818	Rotor		

## 11 EU Declaration of Conformity

Manufacturer: **KSB SE & Co. KGaA**  
**Johann-Klein-Straße 9**  
**67227 Frankenthal (Germany)**

This EU Declaration of Conformity is issued under the sole responsibility of the manufacturer.

The manufacturer herewith declares that **the product:**

### **Calio S, Calio-Therm S**

**From serial number: xxxxxxxx-A201920-00001**

- is in conformity with the provisions of the following Directives as amended from time to time:
  - 2009/125/EC: Creation of a framework for the stipulation of requirements for the environmentally compatible design of energy-related products (Ecodesign Directive), Regulation No. 641/2009 and/or 622/2012
  - Electrical components<sup>6)</sup>: 2011/65/EU Restriction of the use of certain hazardous substances in electrical and electronic equipment (RoHS)
  - 2014/30/EU: Electromagnetic Compatibility (EMC)
  - 2014/35/EU: Electrical Equipment Designed for Use within Specific Voltage Limits (Low Voltage)

The manufacturer also declares that

- the following harmonised international standards have been applied:
  - EN 60335-1, EN 60335-2-51
  - EN 55014-1, EN 55014-2
  - EN 61000-3-2, EN 61000-3-3
  - EN 16297-1, EN 16297-2

Person authorised to compile the technical file:

Jennifer Watson  
Project Coordination Pump Systems and Drives  
KSB SE & Co. KGaA  
Johann-Klein-Straße 9  
67227 Frankenthal (Germany)

The EU Declaration of Conformity was issued in/on:

Frankenthal, 1 July 2019

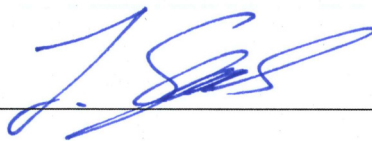

---

Jochen Schaab  
Head of Product Development Pump Systems and Drives  
KSB SE & Co. KGaA  
Johann-Klein-Straße 9  
67227 Frankenthal

---

6) Where applicable

---

## Index

### A

Applications 8  
Automatic functions 14

### B

Bearings 14

### C

Commissioning 23  
Connections 14

### D

Design 14  
Designation 13  
Disposal 12  
Drive 14

### E

Event of damage 6

### F

Faults  
    Causes and remedies 42  
Fluid handled  
    Density 26

### I

Installation at site 17  
Intended use 8

### K

Key to safety symbols/markings 7

### M

Manual functions 14

### N

Name plate 13

### O

Operating limits 25  
Operating modes 14  
Other applicable documents 6

### P

Piping 19  
Preservation 11, 27  
Product description 13

### R

Return to supplier 12  
Returning to service 28

### S

Safety 8  
Safety awareness 9  
Scope of supply 16  
Shutdown 27  
Signalling and display functions 14  
Start-up 24  
Storage 11, 27

### W

Warnings 7  
Warranty claims 6







**KSB SE & Co. KGaA**

Johann-Klein-Straße 9 • 67227 Frankenthal (Germany)

Tel. +49 6233 86-0

[www.ksb.com](http://www.ksb.com)

1157.811/06-EN (05029825)