

SCALA2

Installation and operating instructions



English (GB) Installation and operating instructions

Original installation and operating instructions

These installation and operating instructions describe Grundfos SCALA2 domestic water supply pumps.

Sections 1-5 give the information necessary to be able to unpack, install and start up the product in a safe way.

Sections 6-14 give important information about the product, as well as information on service, fault finding and disposal of the product.

CONTENTS

	Page
1. General information	2
1.1 Target group	2
1.2 Hazard statements	2
1.3 Notes	3
2. Receiving the product	3
2.1 Inspecting the product	3
2.2 Scope of delivery	3
3. Installing the product	3
3.1 Location	3
3.2 System sizing	3
3.3 Mechanical installation	3
3.4 Electrical connection	6
4. Starting up the product	6
4.1 Priming the pump	6
4.2 Starting the pump	6
4.3 How to set the correct pressure	7
4.4 Shaft seal run-in	7
5. Handling and storing the product	7
5.1 Handling the product	7
5.2 Storing the product	7
6. Product introduction	7
6.1 Product description	7
6.2 Intended use	8
6.3 Pumped liquids	8
6.4 Identification	8
7. Control functions	9
7.1 Menu overview, SCALA2	9
8. Setting the product	10
8.1 Setting the outlet pressure	10
8.2 Locking and unlocking the operating panel	10
8.3 Expert settings, SCALA2	10
8.4 Resetting to factory settings	11
9. Servicing the product	11
9.1 Maintaining the product	11
9.2 Customer service information	12
9.3 Service kits	12
10. Starting up the product after standstill	12
10.1 Deblocking the pump	12
11. Taking the product out of operation	12
12. Fault finding the product	13
12.1 Grundfos Eye operating indications	13
12.2 Fault resetting	13
12.3 Fault finding chart	14
13. Technical data	16
13.1 Operating conditions	16
13.2 Mechanical data	16
13.3 Electrical data	16
13.4 Dimensions and weights	16
14. Disposing of the product	16



Read this document and the quick guide before installing the product. Installation and operation must comply with local regulations and accepted codes of good practice.



This appliance can be used by children aged from 8 years and above and persons with reduced physical, sensory or mental capabilities or lack of experience and knowledge if they have been given supervision or instruction concerning use of the appliance in a safe way and understand the hazards involved.

Children shall not play with the appliance. Cleaning and user maintenance shall not be made by children without supervision.

1. General information

1.1 Target group

These installation and operating instructions are intended for professional as well as non-professional users.

1.2 Hazard statements

The symbols and hazard statements below may appear in Grundfos installation and operating instructions, safety instructions and service instructions.



DANGER

Indicates a hazardous situation which, if not avoided, will result in death or serious personal injury.



WARNING

Indicates a hazardous situation which, if not avoided, could result in death or serious personal injury.



CAUTION

Indicates a hazardous situation which, if not avoided, could result in minor or moderate personal injury.

The hazard statements are structured in the following way:



SIGNAL WORD

Description of hazard

Consequence of ignoring the warning.

- Action to avoid the hazard.

1.3 Notes

The symbols and notes below may appear in Grundfos installation and operating instructions, safety instructions and service instructions.



Observe these instructions for explosion-proof products.



A blue or grey circle with a white graphical symbol indicates that an action must be taken.



A red or grey circle with a diagonal bar, possibly with a black graphical symbol, indicates that an action must not be taken or must be stopped.



If these instructions are not observed, it may result in malfunction or damage to the equipment.



Tips and advice that make the work easier.

2. Receiving the product

2.1 Inspecting the product

Check that the product received is in accordance with the order. Check that the voltage and frequency of the product match the voltage and frequency of the installation site. See section [6.4.1 Nameplate](#).

2.2 Scope of delivery

The box contains the following items:

- 1 Grundfos SCALA2 pump
- 1 quick guide
- 1 safety instructions booklet.

3. Installing the product

3.1 Location

The pump can be installed indoors or outdoors, but it must not be exposed to frost.

We recommend that you install the pump near a drain or in a drip tray connected to a drain in order to lead away possible condensation from cold surfaces.



Install the pump in such a way that no undesirable collateral damage can arise due to leakage. If the unlikely event of an internal leakage occurs, the liquid will be drained through the bottom of the pump.

3.1.1 Minimum space

The pump requires a minimum space of 430 x 215 x 325 mm (17 x 8.5 x 12.8 inches).

Even though the pump does not require much space, we recommend that you leave enough space for service and maintenance access.

3.1.2 Installing the product in frosty environment

Protect the pump from freezing if it is to be installed outdoors where frost may occur.

3.2 System sizing



Make sure that the system in which the pump is incorporated is designed for the maximum pump pressure.

The pump is factory-set to 3 bar (44 psi) outlet pressure which can be adjusted according to the system in which it is incorporated.

The tank precharge pressure is 1.25 bar (18 psi).

In case of suction lift of more than six metres, the pipe resistance on the outlet side must be at least two metres water column or 3 psi at any given flow in order to obtain optimum operation.

3.3 Mechanical installation

DANGER

Electric shock



Death or serious personal injury

- Switch off the power supply before starting any work on the product. Make sure that the power supply cannot be accidentally switched on.

3.3.1 Positioning the product

Always mount the pump on the base plate in a horizontal position with a maximum inclination angle of $\pm 5^\circ$.

3.3.2 Foundation

Fasten the pump to a solid horizontal foundation by means of screws through the holes in the base plate. See figs 1 and 2.

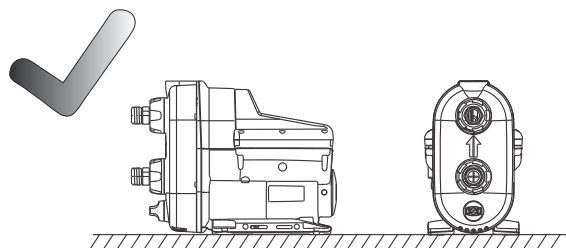

Fig. 1 Horizontal foundation

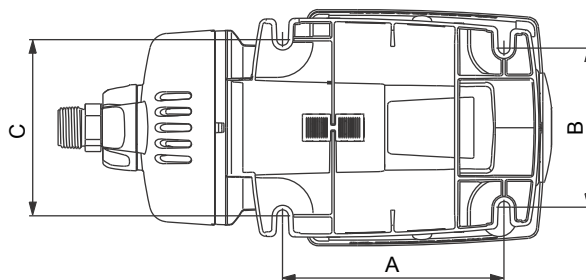

Fig. 2 Base plate

	[mm (inches)]
A	181 (7.13)
B	130 (5.12)
C	144 (5.67)

TM06 5729 5315

TM06 3809 1015

3.3.3 Connecting the piping system



Make sure that the pump is not stressed by the piping system.



Always loosen and tighten the union nuts on the inlet and outlet ports by hand. Damage to the inlet and outlet parts increases the risk of leakage.

1. Turn the union nuts by hand to loosen the inlet and outlet ports. See fig. 3.
2. Seal the pipe fittings with thread sealing tape.
3. Carefully screw the inlet and outlet connections to the pipe fittings using a pipe wrench or similar tool. Keep the union nut on the pipe fitting if you have removed it from the pump. The pump is equipped with flexible connections, $\pm 5^\circ$, to facilitate the connection of inlet and outlet pipes.
4. Fasten the connections to the inlet and outlet. Hold the connection with one hand and tighten the union nut with the other hand.

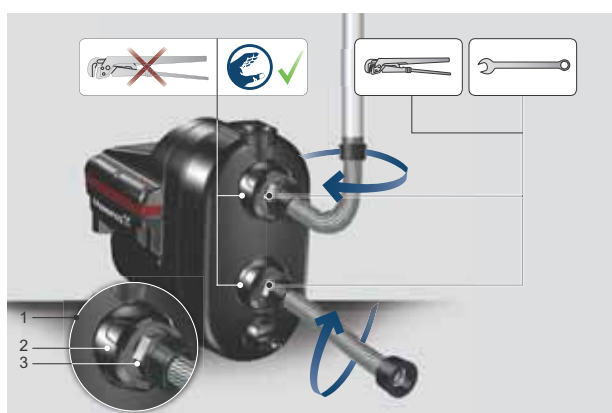

Fig. 3 How to fit the connections

TM06 4318 1915

Pos.	Description
1	Inlet and outlet port
2	Union nut
3	Pipe fitting

3.3.4 How to reduce noise in the installation



We recommend to use flexible hoses and mount the pump on a vibration-damping rubber pad.

Vibrations from the pump may be transferred to the surrounding structure and create noise in the 20-1000 Hz spectrum, also called the bass spectrum.

Correct installation using a vibration-damping rubber pad, flexible hoses and correctly placed pipe hangers for rigid pipes can reduce the noise experienced by up to 50 %. See fig. 4.

Place pipe hangers for the rigid pipes close to the connection of the flexible hose.

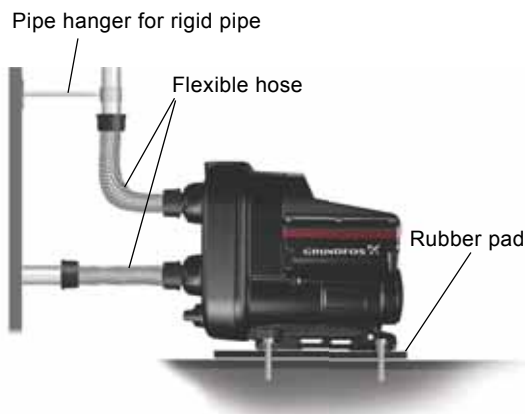

Fig. 4 How to reduce noise in the installation

TM06 4321 1915

3.3.5 Installation examples

Fittings, hoses and valves are not supplied with the pump. We recommend to follow the installation examples in sections 3.3.6 to 3.3.8.

3.3.6 Mains water pressure boosting

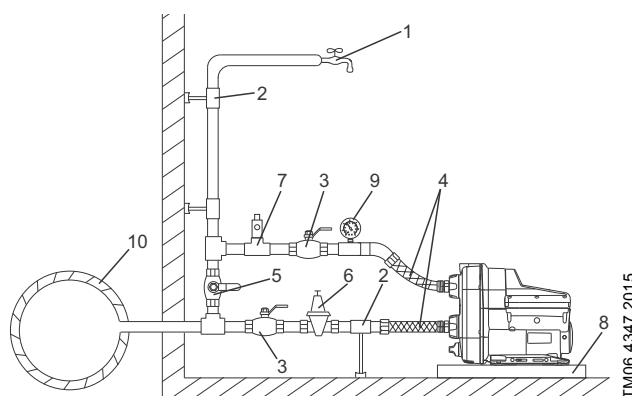

Fig. 5 Mains water pressure boosting

TM06 4347 2015

Pos.	Description
1	Highest tapping point
2	Pipe hangers and supports
3	Isolating valves
4	Flexible hoses
5	Bypass valve
6	Optional pressure-reducing valve on the inlet side if the inlet pressure can exceed 10 bar (145 psi)
7	Optional pressure-relief valve on the outlet side if the installation cannot withstand a pressure of 6 bar (87 psi)
8	Drip tray. Install the pump on a small stand to prevent the ventilation holes from being flooded.
9	Pressure gauge
10	Mains water pipe

3.3.7 Suction from a well

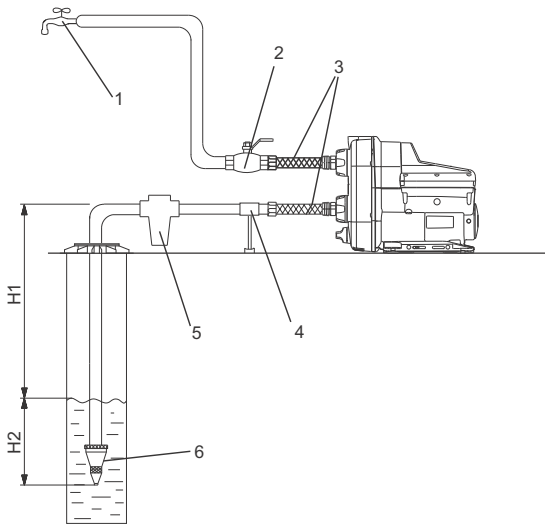

Fig. 6 Suction from a well

TM06 4349 4117

Pos.	Description
1	Highest tapping point
2	Pipe hangers
3	Isolating valve
4	Flexible hoses
5	Drain to sewer
6	Inlet filter. If the water may contain sand, gravel or other debris, please install a filter on the inlet side to protect the pump and installation.
7	Freshwater tank
8	Foot valve with strainer (recommended)
A	Minimum 1 ° inclination

3.3.9 Inlet pipe length

The overview below shows the different possible inlet pipe lengths, depending on the vertical pipe length.

The overview is only intended as a guide.

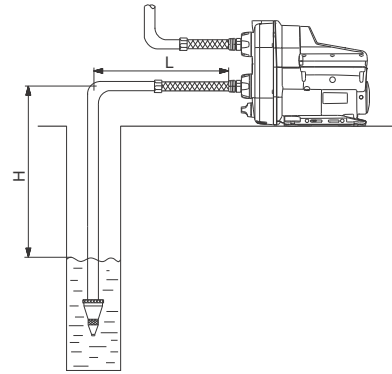

Fig. 8 Inlet pipe length

TM06 4372 4117

Pos.	Description
1	Highest tapping point
2	Isolating valve
3	Flexible hoses
4	Pipe support
5	Inlet filter. If the water may contain sand, gravel or other debris, please install a filter on the inlet side to protect the pump and installation.
6	Foot valve with strainer (recommended).
H1	Maximum suction lift is 8 m (26 ft).
H2	Inlet pipe must be submersed at least 0.5 m (1.64 ft).

3.3.8 Suction from freshwater tank

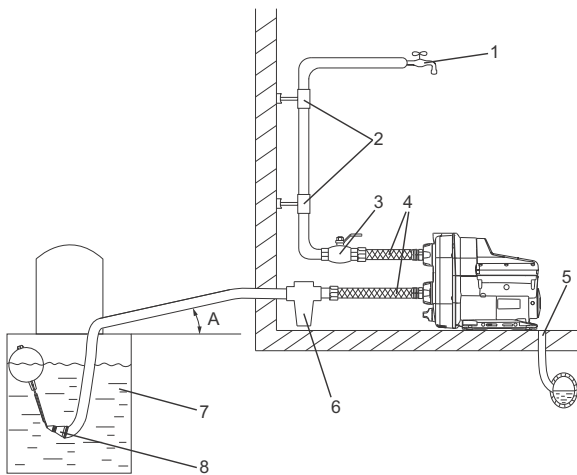

Fig. 7 Suction from freshwater tank

TM06 4348 4117

DN 32		DN 40	
H [m (ft)]	L [m (ft)]	H [m (ft)]	L [m (ft)]
0 (0)	68 (223)	0 (0)	207 (679)
3 (10)	43 (141)	3 (10)	129 (423)
6 (20)	17 (56)	6 (20)	52 (171)
7 (23)	9 (30)	7 (23)	26 (85)
8 (26)	0 (0)	8 (26)	0 (0)

Preconditions:

Maximum flow velocity: 1 l/s (16 gpm).

Inside roughness of pipes: 0.01 mm (0.0004 inch).

Size	Inside pipe diameter [mm (inches)]	Pressure loss [m/m (psi/ft)]
DN 32	28 (1.1)	0.117 (5/100)
DN 40	35.2 (1.4)	0.0387 (1.6/100)

3.4 Electrical connection



Carry out the electrical connection according to local regulations.

Check that the supply voltage and frequency correspond to the values stated on the nameplate.

DANGER

Electric shock

Death or serious personal injury

- Switch off the power supply before starting any work on the product. Make sure that the power supply cannot be accidentally switched on.



DANGER

Electric shock

Death or serious personal injury

- The pump must be earthed.
- The pump is supplied with a grounding conductor and grounding-type attachment plug. To reduce the risk of electric shock, be certain that the pump is connected only to a properly grounded, grounding type receptacle (protective earthing).
- If national legislation requires a Residual Current Device (RCD), a Ground Fault Circuit Interrupter (GFCI), or equivalent in the electrical installation, this must be type B (according to UL/IEC 61800-5-1) or better, due to the nature of the constant DC leakage current.



If the power supply cable is damaged, it must be replaced by the manufacturer, his service agent or similarly qualified persons in order to avoid hazard.



We recommend that you fit the permanent installation with a residual-current circuit breaker (RCCB) with a tripping current less than 30 mA.

3.4.1 Motor protection

The pump incorporates current and temperature dependent motor protection.

3.4.2 Plug connection

DANGER

Electric shock

Death or serious personal injury

- Check that the power plug delivered with the product is in compliance with local regulations.
- Make sure that the pump is connected only to a properly grounded, grounding-type receptacle (protective earthing).
- The protective earth of the power outlet must be connected to the protective earth of the pump. The plug must therefore have the same PE connection system as the power outlet. If not, use a suitable adapter.



3.4.3 Connection without plug



The electrical connection must be carried out by an authorised electrician in accordance with local regulations.

DANGER

Electric shock

Death or serious personal injury

- The pump must be connected to an external main switch with a minimum contact gap of 3 mm (0.12 inch) in all poles.



4. Starting up the product



Do not start the pump until it has been filled with liquid.

4.1 Priming the pump

1. Unscrew the priming plug and pour minimum 1.7 litres (0.45 gallons) of water into the pump housing. See fig. 9.
2. Screw the priming plug on again.



If the suction depth exceeds 6 m (20 ft), it may be necessary to prime the pump more than once.



Always tighten priming and drain plugs by hand.

4.2 Starting the pump

1. Open a tap to prepare the pump for venting.
 2. Insert the power plug into the socket or turn on the power supply and the pump will start.
 3. When water flows without air, close the tap.
 4. Open the highest tapping point in the installation, preferably a shower.
 5. Adjust the pressure setpoint to the required pressure by means of the  buttons. See section 4.3 *How to set the correct pressure*.
 6. Close the tapping point.
- Startup has been completed.



Fig. 9 Priming the pump

4.3 How to set the correct pressure

The pump can be set to provide a water pressure between 1.5 to 5.5 bar (22 to 80 psi) at intervals of 0.5 bar (7 psi).

The factory setting is 3 bar (44 psi). See section [3.2 System sizing](#).



We recommend to use the default pressure of 3.0 bar (44 psi) which will suit most applications.



The difference between the inlet pressure and outlet pressure must not exceed 3.5 bar (51 psi).

Example: If the inlet pressure is 0.5 bar (7 psi), the maximum outlet pressure is 4 bar (58 psi).



If you set the pressure too high, this might cause the pump to operate for up to three minutes after the tap is turned off.

4.3.1 Boosting from a well or a tank

If you are boosting from a well or a tank, make sure not to set the pressure setpoint too high. The difference between the inlet pressure and outlet pressure must not exceed 3.5 bar (51 psi).

Maximum setpoint	[bar (psi)]
Well application	3.0 (44)
Tank below ground level	3.5 (51)
Tank above ground level	4.0 (58)

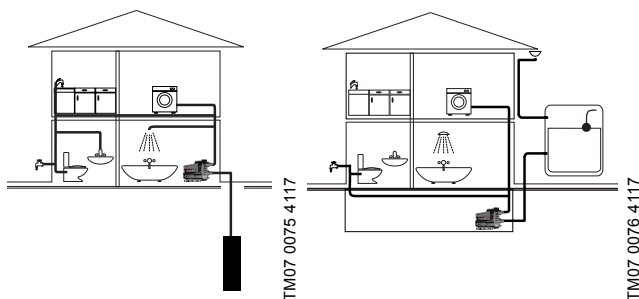

Fig. 10 Boosting from a well or a tank

4.3.2 Boosting from the mains

The pressure settings 4.5, 5.0 and 5.5 bar (65, 73 and 80 psi) require a positive inlet pressure and these settings must only be used when boosting from the water mains.

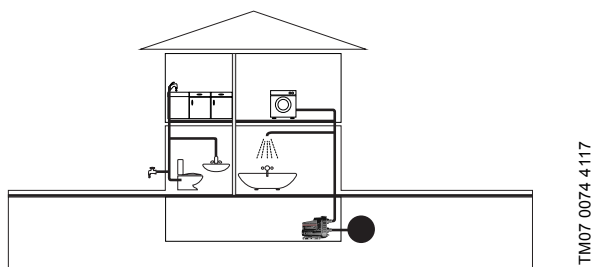

Fig. 11 Boosting from the mains

4.3.3 Self-learning setpoint

If the pump cannot reach the user-defined pressure setpoint, the self-learning function will automatically lower the setpoint. See section [8.3.2 Self-learning function](#).

4.4 Shaft seal run-in

The shaft seal faces are lubricated by the pumped liquid. A slight leakage from the shaft seal of up to 10 ml per day or 8 to 10 drops per hour may occur.

When the pump is started up for the first time, or when the shaft seal has been replaced, a certain run-in period is required before the leakage is reduced to an acceptable level. The time required for this depends on the operating conditions, that is, every time the operating conditions change, a new run-in period will be started.

Under normal conditions, the leaking liquid will evaporate. As a result, no leakage will be detected.

The leakage is visible where the screws are mounted on the base plate. If the unlikely event of an internal leakage occurs, the liquid will be drained through the bottom of the pump. Install the pump in such a way that no undesirable collateral damage can arise.

5. Handling and storing the product

5.1 Handling the product



Take care not to drop the pump as it may break.

5.2 Storing the product

If the pump is to be stored for a period of time, for example during the winter, drain it and store it indoors in a dry location. See section [10. Starting up the product after standstill](#).

Temperature range during storing must be -40 to 70 °C (-40 to 158 °F).

Maximum relative humidity during storing: 95 % RH.

6. Product introduction

6.1 Product description

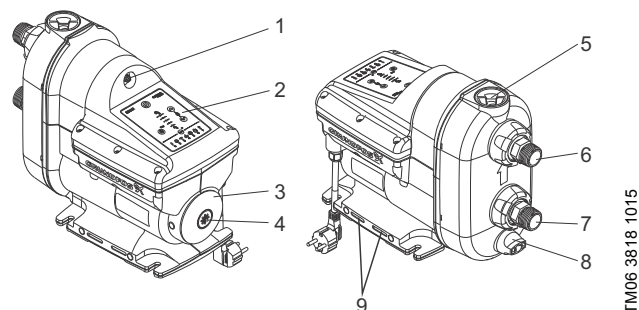

Fig. 12 Grundfos SCALA2 pump

Pos.	Description
1	Air valve for built-in pressure tank
2	Operating panel. See section 7. Control functions .
3	Nameplate. See section 6.4.1 Nameplate .
4	Plug for access to pump shaft. See section 10.1 Deblocking the pump .
5	Priming plug. See section 4.1 Priming the pump .
6	Outlet opening. See section 3.3.3 Connecting the piping system .
7	Inlet opening. See section 3.3.3 Connecting the piping system .
8	Drain plug. See section 6.4 Identification .
9	Ventilation holes. They must not be flooded.

The inlet and outlet openings include flexible connections of $\pm 5^\circ$.

6.2 Intended use



This pump has been evaluated for use with water only.

Only use SCALA2 pumps according to the specifications stated in these installation and operating instructions.

The pump is suitable for pressure boosting of fresh water in domestic water supply systems.

6.3 Pumped liquids

The pump is designed for fresh water with a maximum chloride content of 300 ppm and a free chlorine content below 1 ppm.

The pump is not suitable for these liquids:

- liquids containing long fibres
- flammable liquids (oil, petrol, etc.)
- aggressive liquids.



If the water can contain sand, gravel or other debris, there is a risk of pump blockage.

Please install a filter on the inlet side or apply a floating strainer to protect the pump.

6.4 Identification

6.4.1 Nameplate

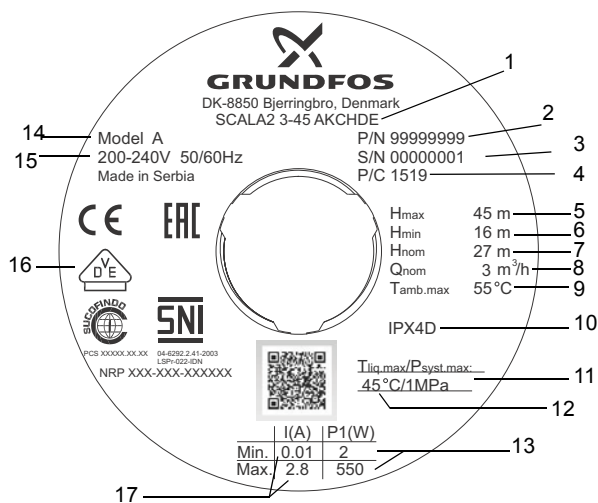

TM06 4340 2015

Fig. 13 Example of nameplate

Pos.	Description
1	Type designation
2	Product number
3	Serial number
4	Production code, year and week
5	Maximum head
6	Minimum head
7	Rated head
8	Rated flow rate
9	Maximum ambient temperature
10	Enclosure class
11	Maximum operation pressure
12	Maximum liquid temperature
13	Minimum and maximum rated power
14	Model
15	Voltage and frequency
16	Approvals
17	Minimum and maximum rated current

6.4.2 Type key

	SCALA2	3	-45	A	K	C	H	D	E
Type range	SCALA2								
Rated flow rate	3: [m ³ /h]								
Maximum head	45: [m]								
Material code	A: Standard								
Supply voltage	K: 1 x 200-240 V, 50/60 Hz M: 1 x 208-230 V, 60 Hz V: 1 x 115 V, 60 Hz W: 1 x 100-115 V, 50/60 Hz								
Motor	C: High-efficiency motor with frequency converter								
Mains cable and plug	A: Cable with plug, IEC type I, AS/NZS3112, 2 m B: Cable with plug, IEC type B, NEMA 5-15P, 6 ft C: Cable with plug, IEC type E&F, CEE7/7, 2 m D: Cable without plug, 2 m G: Cable with plug, IEC type G, BS1363, 2 m H: Cable with plug, IEC type I, IRAM 2073, 2 m J: Cable with plug, NEMA 6-15P, 6 ft K: Cable with plug, IEC type B, JIS C 8302, 2 m L: Cable with plug, IEC type L, CEI 23-16/VII, 2 m O: Cable with plug, IEC type O, TIS 166-2549, 2 m								
Controller	D: Integrated frequency converter								
Thread	E: R 1" composite material F: NPT 1" composite material								

7. Control functions

7.1 Menu overview, SCALA2



Fig. 14 SCALA2 operating panel

SCALA2	Function
	On/off
	Increases the outlet pressure.
	Decreases the outlet pressure.
	Resets alarms.
	Indicates the required outlet pressure.
	Indicates that the pump has been stopped manually.
	Indicates that the operating panel is locked.

7.1.1 Pressure indicator, SCALA2

The pressure indicator shows the required outlet pressure from 1.5 to 5.5 bars (22 to 80 psi) in 0.5 bar (7.5 psi) intervals.

The illustration below shows a pump set to 3 bar (44 psi) indicated by two green lights, and a pump set to 3.5 bar (51 psi) indicated by one green light.

Flashing green lights indicate that the pump has automatically lowered the pressure. See section [4.3.3 Self-learning setpoint](#).



Fig. 15 SCALA2 outlet pressure indication

	BAR	PSI	Water column [m]	kPa	MPa
	5.5	80	55	550	0.55
	5.0	73	50	500	0.50
	4.5	65	45	450	0.45
	4.0	58	40	400	0.40
	3.5	51	35	350	0.35
	3.0	44	30	300	0.30
	2.5	36	25	250	0.25
	2.0	30	20	200	0.20
	1.5	22	15	150	0.15

Fig. 16 Pressure indication table

7.1.2 Indicator lights for SCALA2

Indications	Description
	Operating indications
	The operating panel is locked.
	Power supply failure
	The pump is blocked, for instance the shaft seal has seized up.
	Leakage in the system
	Dry running or water shortage*
	The maximum pressure has been exceeded or the setpoint cannot be reached.
	The maximum runtime has been exceeded.
	The temperature is outside the range.

* For fault number 4, dry running, the pump must be reset manually. For fault number 4, water shortage, and the remaining faults, 1, 2, 3, 5, 6 and 7, the pump will reset whenever the cause has disappeared or been remedied. See section [8.3.3 Auto reset](#).

For further information about system status, see section [12. Fault finding the product](#).

TM06 3301 5114

TM06 4345 2015

TM06 4187 4117

8. Setting the product

The pump will remember the controller settings even if it is turned off.

8.1 Setting the outlet pressure

Adjust the outlet pressure by pressing ▲▼.

8.2 Locking and unlocking the operating panel

The operating panel can be locked, which means that the buttons do not function and no settings can be changed accidentally.

How to lock the operating panel

1. Hold down the ▲▼ buttons simultaneously for 3 seconds.
2. The operating panel is locked when 🔒 symbol lights up.

How to unlock the operating panel

1. Hold down the ▲▼ buttons simultaneously for 3 seconds.
2. The operating panel is unlocked when 🔒 symbol turns off.

8.3 Expert settings, SCALA2



Expert settings are for installers only.

The expert setting menu allows the installer to toggle between the following functions:

- self-learning
- auto reset
- anti cycling
- maximum continuous operating time.

8.3.1 Accessing the expert settings

Proceed as follows:

1. Hold down the ⏻ button for 5 seconds.
2. The ⚡ symbol will start flashing to indicate that the expert settings are active.

The pressure indicator now acts as the expert menu. A flashing green diode is the cursor. Move the cursor using the ▲▼ buttons, and toggle the selection on or off using the ⏻ button. The diode for each setting will light up when the setting is active.

- ▲ Move cursor up.
- ▼ Move cursor down.
- ⏻ Toggle settings.



Self-learning
Auto reset
Anti cycling
Maximum continuous operating time
Exit expert menu

Fig. 17 Expert menu overview

TM06 43346 4 117

8.3.2 Self-learning function

The factory setting for this function is "on".

On

If the pump cannot reach the user-defined pressure setpoint, the self-learning function will automatically adjust the setpoint.

The pump will lower the setpoint to either 4.5, 3.5 or 2.5 bar (65, 51 or 36 psi).

The self-learned setpoint is indicated on the operating panel by one flashing green light.

After every 24 hours, the pump will automatically attempt to revert to the original user-defined setpoint. If this is not possible, the pump will again return to the self-learned setpoint. The pump will continue to operate with the self-learning setpoint, until the user-defined setpoint can be reached.

Example:

The user-defined pressure is set to 5 bar (72 psi), indicated by constant green lights on the pressure indicator panel.

The pump is unable to reach this pressure due to negative pressure on the inlet side.

The self-learning function automatically adjusts the setpoint to 3.5 bar (51 psi), indicated by one flashing green light on the pressure indicator panel.

After 24 hours, the pump will automatically try to adjust the setpoint back to 5 bar (72 psi).



Fig. 18 User-defined setpoint (left) and self-learned setpoint (right)

How to reset the self-learned setpoint

1. You can manually reset the settings by pressing any button on the operating panel. The pump will immediately try to reach the original setpoint.
2. If the pump keeps reducing the setpoint due to self-learning, we recommend to reduce the setpoint manually on the operating panel.

Off

If you set the self-learning function to off and the pump is unable to reach the desired setpoint, the pump will show alarm 5.

8.3.3 Auto reset

The factory setting for this function is "on".

On

This function allows the pump to automatically check if the operating conditions are back to normal. If the operating conditions are back to normal, the alarm indication will be reset automatically.

The auto reset function works in the following way:

Indication	Action
Water shortage	The pump will attempt eight restarts at five-minute intervals. If not successful, this cycle will be repeated after 24 hours.
Dry running (pump not primed)	Prime the pump and reset it manually.
All other indications	The pump will attempt three restarts within the first 60 seconds, then eight restart attempts at five-minute intervals. If not successful, this cycle will be repeated after 24 hours.

For indications, see section [7.1.2 Indicator lights for SCALA2](#).

Off

All alarms must be reset manually by means of the  button.

8.3.4 Anti cycling

The factory setting for this function is "off".

This function monitors the starts and stops of the pump.

Off

If the pump starts 40 times in a fixed pattern, there will be an alarm. The pump will remain in operation as normal.

On

If the pump starts and stops in a fixed pattern, there is a leakage in the system, and the pump will stop and show alarm 3.



Leakage in the system.

8.3.5 Maximum continuous operating time

The factory setting for this function is "off".

This function is a timer that can turn off the pump if it runs continuously for 30 minutes.

Off

If the pump exceeds the running time of 30 minutes, the pump will run depending on the flow.



On

If the pump exceeds the running time of 30 minutes, the pump will stop after 30 minutes of continuous operation, and it will show alarm 6. This alarm will always need to be reset manually.



Maximum runtime exceeded.

8.4 Resetting to factory settings

The pump can be reset to factory setting by pressing the   buttons simultaneously for 5 seconds.

9. Servicing the product

DANGER

Electric shock



Death or serious personal injury

- Before starting any work on the product, make sure that the power supply has been switched off and that it cannot be accidentally switched on.

9.1 Maintaining the product

9.1.1 Insect filter

The pump has an insect filter to prevent insects from nesting in the pump.

The filter is placed on the bottom and can easily be removed and cleaned with a stiff brush. See fig. 19.

Clean the insect filter once a year or as needed.

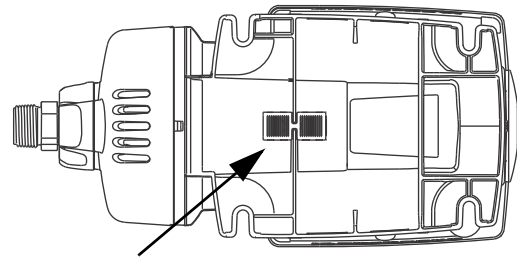

Fig. 19 Insect filter

9.1.2 Inlet and outlet valves

The pump is maintenance-free, but we recommend that you check and clean the inlet and outlet non-return valves once a year or as needed.

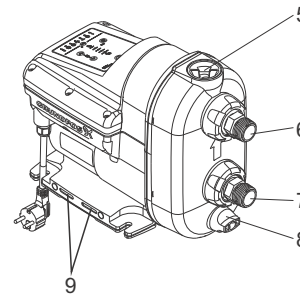

Fig. 20 SCALA2 pump

To remove the inlet non-return valve, follow the steps below:

1. Turn off the power supply and disconnect the power plug.
2. Shut off the water source.
3. Open a tap to release the pressure in the pipe system.
4. Close the isolating valves and/or drain the pipes.
5. Gradually open and remove the priming plug. See fig. 20 (5).
6. Remove the drain plug and drain the pump. See fig. 20 (8).
7. Unscrew the union nut holding the inlet connection. See fig. 20 (7). Depending on the installation type, it may be necessary to remove the pipes from both the inlet and outlet connections.
8. Pull out the inlet connection.
9. Pull out the inlet non-return valve.
10. Clean the non-return valve with warm water and a soft brush.
11. Assemble the components in reverse order.

TM06 4537 2515

TM06 3818 1015

To remove the outlet non-return valve, follow the steps below:

1. Turn off the power supply and disconnect the power plug.
2. Shut off the water source.
3. Open a tap to release the pressure in the pipe system.
4. Close the isolating valves and/or drain the pipes.
5. Gradually open and remove the priming plug. See fig. 20 (5). The plug and non-return valve are one unit.
6. Clean the non-return valve with warm water and a soft brush.
7. Assemble the components in reverse order.



Fig. 21 Outlet and inlet non-return valves

9.2 Customer service information

For further information on service parts, see Grundfos Product Center on www.product-selection.grundfos.com.

9.3 Service kits

For further information on service kits, see Grundfos Product Center on www.grundfos.com.

10. Starting up the product after standstill

1. Check that the pump is not blocked by following the instructions in section [10.1 Deblocking the pump](#).
2. If the pump has been drained, it must be filled with liquid before startup. See section [4.1 Priming the pump](#).
3. Start up the pump. Follow the instructions in section [4. Starting up the product](#).
4. The pump will remember the controller settings even if it is turned off.

10.1 Deblocking the pump

DANGER

Electric shock



Death or serious personal injury

- Switch off the power supply before starting any work on the product. Make sure that the power supply cannot be accidentally switched on.

The end cover incorporates a plug which can be removed by means of a suitable tool. This makes it possible to deblock the pump shaft if it has seized up as a result of inactivity.

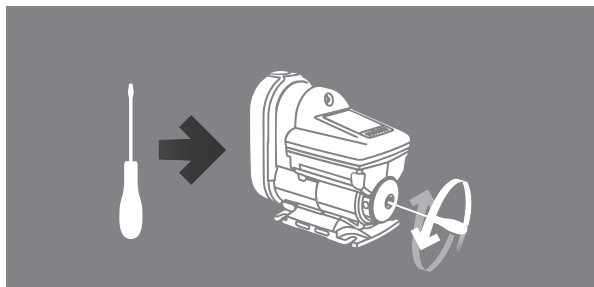

Fig. 22 Debblocking the pump

11. Taking the product out of operation

If the pump is taken out of operation for a period of time, for example during the winter, it must be disconnected from the power supply and placed in a dry location.

Proceed as follows:

1. Stop the pump by means of the on/off button .
2. Disconnect the power supply.
3. Open a tap to release the pressure in the pipe system.
4. Close the isolating valves and/or drain the pipes.
5. Gradually loosen the priming plug to release the pressure in the pump.
6. Remove the drain plug to drain the pump. See fig. 23.
7. We recommend to store the pump indoors in a dry location. Due to humidity, the disconnected pump must not be left outside for a longer period of time.



Fig. 23 Draining the pump





TM06 4331 1915

TM06 4202 1615

TM06 4203 1615

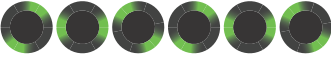
12. Fault finding the product

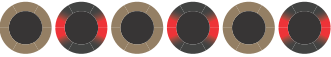
12.1 Grundfos Eye operating indications

Grundfos Eye	Indication	Description
	No lights are on.	The power is off. The pump is not running.
	Two opposite green indicator lights running in the direction of rotation of the pump.	The power is on. The pump is running.
	Two opposite green indicator lights at a 45 ° angle is the icon used throughout this document for pump running.	The power is on. The pump is running.
	Two opposite green indicator lights permanently on.	The power is on. The pump is not running.
	Two opposite red indicator lights flashing simultaneously.	Alarm. The pump has stopped.
	Two opposite red indicator lights is the icon used throughout this document for pump stopped.	Alarm. The pump has stopped.

12.2 Fault resetting

You can reset a fault indication in one of the following ways:

- When you have eliminated the fault cause, reset the pump manually by pressing the  button. The pump will then revert to normal duty.
- If the fault disappears by itself, the pump will attempt to reset automatically and the fault indication will disappear if automatic reset is successful and provided that you have enabled the auto reset function in the service menu.

















12.3 Fault finding chart

DANGER**Electric shock**

Death or serious personal injury

- Before starting any work on the product, make sure that the power supply has been switched off and that it cannot be accidentally switched on.

Fault	Grundfos Eye	Indicator light	Automatic reset	Cause	Remedy
1. The pump is not running.		-	-	a) Power supply failure.	Switch on the power supply. Check the cables and cable connections for defects and loose connections and check for blown fuses in the electrical installation.
			Yes	b) The power supply is out of prescribed voltage range.	Check the power supply and the pump nameplate. Reestablish the power supply within the prescribed voltage range.
			No	c) The shaft seal has seized up.	See section 10. <i>Starting up the product after standstill.</i>
			No	d) The pump is blocked by impurities.	See section 10. <i>Starting up the product after standstill.</i> Contact Grundfos Service if the problem persists.
			Yes	e) Dry running.	Check the water source, and prime the pump.
			No	f) The maximum runtime has been exceeded.	Check the installation for leakage and reset the alarm.
			No	g) The internal non-return valve is defective or blocked in completely or partly open position.	Clean, repair or replace the non-return valve. See section 9. <i>Servicing the product.</i>
2. The pump is running.			-	a) Leakage from the pipe system, or the non-return valve is not properly closed due to impurities.	Check and repair the pipe system, or clean, repair or replace the non-return valve.
			-	b) Small continuous consumption.	Check the taps and reconsider the usage pattern (ice machines, water evaporators for air-conditioning, etc.).
			-	c) The temperature of the pump and water is below 3 °C.	Consider protecting the pump and the installation against frost.
3. The pump performance is insufficient.		-	-	a) The pump inlet pressure is too low.	Check the inlet conditions of the pump.
		-	-	b) The pump is undersized.	Replace the pump with a bigger pump.
		-	-	c) The inlet pipe, the inlet strainer or the pump is partly blocked by impurities.	Clean the inlet pipe or the pump.
		-	-	d) There is a leakage in the inlet pipe.	Repair the inlet pipe.
		-	-	e) There is air in the inlet pipe or the pump.	Prime the inlet pipe and the pump. Check the inlet conditions of the pump.
		-	-	f) The required outlet pressure is too low for the installation.	Increase the pressure setting (arrow up).
			Yes	g) The maximum temperature has been exceeded and the pump is running at reduced performance.	Check the cooling conditions. Protect the pump against direct sunlight or any nearby heat sources.

Fault	Grundfos Eye	Indicator light	Automatic reset	Cause	Remedy
4. System overpressure.			Yes	a) The setpoint is set too high. The difference between the outlet pressure and the inlet pressure must not exceed 3.5 bar (51 psi).	Reduce the pressure to a new setpoint (maximum 3.5 bar (51 psi) + positive inlet pressure). Example: If the inlet pressure is 0.5 bar (7 psi), the maximum outlet pressure is 4 bar (58 psi).
			Yes	b) The maximum pressure has been exceeded, the inlet pressure is higher than 6 bar, 0.6 MPa (87 psi).	Check the inlet conditions.
			Yes	c) The maximum pressure has been exceeded. Equipment elsewhere in the system causes a high pressure at the pump, for example water heater or defective safety equipment.	Check the installation.
5. You can reset the pump, but it runs only for a few seconds.			Yes	a) Dry running or water shortage.	Check the water source, and prime the pump.
			Yes	b) The inlet pipe is blocked by impurities.	Clean the inlet pipe.
			Yes	c) The foot or non-return valve is blocked in closed position.	Clean, repair or replace the foot or non-return valve.
			Yes	d) There is a leakage in the inlet pipe.	Repair the inlet pipe.
			Yes	e) Air in the inlet pipe or the pump.	Prime the inlet pipe and the pump. Check the inlet conditions of the pump.
6. You can reset the pump, but it starts repeatedly, immediately after stopping.			No	a) The internal non-return valve is defective or blocked in completely or partly open position.	Clean, repair or replace the non-return valve.
			No	b) The tank precharge pressure is not correct.	Adjust the tank precharge pressure to 70 % of the required outlet pressure.

13. Technical data

13.1 Operating conditions

Temperature	[°C (°F)]
Maximum ambient temperature:	
1 x 208-230 V, 60 Hz:	45 (113)
1 x 115 V, 60 Hz:	45 (113)
1 x 200-240 V, 50/60 Hz:	55 (131)
Maximum liquid temperature:	45 (113)

Pressure	[bar (psi)]	[MPa]
Maximum system pressure:	10 (145)	1
Maximum inlet pressure:	6 (87)	0.6

Other operating data

Maximum head:	45 m (147 ft)
IP rating:	X4D (outdoor installation)
Pumped liquid:	Clean water
Noise level:	< 47 dB(A)*

* 47 dB(A) is measured in a typical application with pressure control mode (2.5 bar (36 psi) and 1 m³/h). In non-typical applications noise might increase up to 58 dB.

13.2 Mechanical data

Pipe connections are R 1" or NPT 1".

13.3 Electrical data

Type	Supply voltage [V]	Frequency [Hz]	I _{max.} [A]	P1 [W]	Stand-by power [W]
					2
SCALA2	1 x 200-240	50/60	2.3 - 2.8	550	2
					2
SCALA2	1 x 208-230	60	2.3 - 2.8	550	2
SCALA2	1 x 115	60	5 - 5.7	560	2

Type	Supply voltage [V]	Frequency [Hz]	Plug
			IEC, type E&F
			IEC, type I
			IEC, type G
			None
SCALA2	1 x 200-240	50/60	
SCALA2	1 x 208-230	60	NEMA 6-15P
SCALA2	1 x 115	60	IEC, type B, NEMA 5-15P

13.4 Dimensions and weights

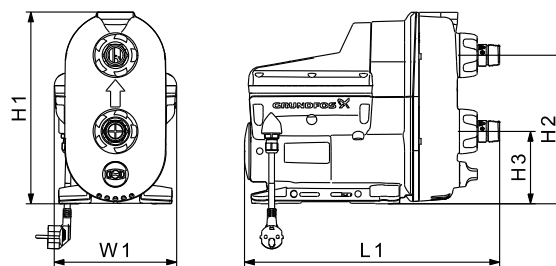

TM06 3305 5114

Type	H1 [mm] [inch]	H2 [mm] [inch]	H3 [mm] [inch]	W1 [mm] [inch]	L1 [mm] [inch]	Weight [kg] [lbs]
SCALA2	302 [11.9]	234 [9.2]	114 [4.5]	193 [7.6]	403 [15.9]	10 [22]

14. Disposing of the product

This product has been designed with focus on the disposal and recycling of materials. The following disposal values apply to all variants of Grundfos SCALA2 pumps:

- minimum 85 % for recycling
- maximum 10 % for incineration
- maximum 5 % for depositing.

Values are percent of total weight.

This product or parts of it must be disposed of in an environmentally sound way:

1. Use the public or private waste collection service.
2. If this is not possible, contact the nearest Grundfos company or service workshop.



The crossed-out wheellie bin symbol on a product means that it must be disposed of separately from household waste. When a product marked with this symbol reaches its end of life, take it to a collection point designated by the local waste disposal authorities. The separate collection and recycling of such products will help protect the environment and human health.

See also end-of-life information at www.grundfos.com/product-recycling.

98880508 0419

ECM: 1252640
